



**HEIDENHAIN**



**Cables and  
Connectors**

Precision encoders require reliable transmission between the encoder and the higher-level electronics. A key role in this is played by the cable and connecting element technology employed.

HEIDENHAIN provides non-assembled, partially assembled, and fully assembled **cables** as encoder accessories that are optimized for the given type of signal transmission (i.e., for specific interfaces). At the same time, special attention has been paid to the operating conditions. HEIDENHAIN cables are subjected to extensive system testing in order to ensure that they meet stringent requirements.

HEIDENHAIN **connecting elements** ensure long-term signal transmission with uninterrupted shielding and low transition resistance. Their rugged and compact design makes them ideal for harsh operating conditions.



 **Further information:**

For comprehensive descriptions of all available interfaces, as well as general electrical information, please refer to the *Interfaces of HEIDENHAIN Encoders* brochure.

Further cables and connecting elements for controls can be found in the OEM brochures for the respective controls.

*This brochure supersedes all previous editions, which thereby become invalid. The basis for ordering from HEIDENHAIN is always the brochure edition valid when the order is made.*

*Standards (ISO, EN, etc.) apply only where explicitly stated in the brochure.*

# Contents

<b>Technical characteristics</b>		
HEIDENHAIN cables and connectors	Areas of application	<b>4</b>
	Terminology for HEIDENHAIN pre-assembled cables	<b>5</b>
General information	Durability and bending characteristics	<b>6</b>
	Information on output cables	<b>8</b>
	General testing accessories for modular encoders and the PWM 21	<b>9</b>
	Usage in drag chains	<b>10</b>
Cable lengths		<b>11</b>
Connecting elements on HEIDENHAIN cables	Overview of connecting elements	<b>15</b>
Hybrid cable technology from HEIDENHAIN	Single-cable solution for servomotors	<b>18</b>
<b>Cable overviews</b>		
	Information on cable overviews	<b>20</b>
	Symbols used in the cable overviews	<b>22</b>
	Adapter cables and connecting cables – EnDat interface (EnDat22) – DRIVE-CLiQ – Fanuc Serial Interface – Mitsubishi high speed interface – Panasonic interface – Yaskawa Serial Interface – EnDat interface (EnDat0x) or SSI interface – 1 V <sub>PP</sub> interface – TTL or HTL interface – 11 μA <sub>PP</sub> interface – Touch probes with EnDat or HTL interface – Touch probes – Digital readouts – Evaluation electronics	<b>23</b>
	Output cables – EnDat interface (EnDat22) – DRIVE-CLiQ – EnDat interface (EnDat01) – 1 V <sub>PP</sub> or TTL interface	<b>41</b>
<b>Cable list</b>		
	Information about the cable list	<b>46</b>
	Cable list sorted by ID number	<b>47</b>
	Signal cables	<b>71</b>
<b>Connecting elements</b>		
Connecting elements	M8, M12, and M23 connecting elements	<b>72</b>
	D-sub connecting elements, HMC 6	<b>74</b>
Pin layouts		<b>76</b>

# HEIDENHAIN cables and connectors

## Areas of application

HEIDENHAIN cables and connecting elements, in conjunction with the given encoders, are deployed in a wide range of industrial production applications, as well as in applications for the medical technology field, metrology laboratories, and positioning devices. The requirements for the cables vary based on the type of application:

### Machine tools

- Resistant to media
- Suitable for drag chains
- Connectable to the encoder for easy replacement
- Convenient routing

### Electronics industry

- Low bend radius
- High bending frequency
- Low bending force

### Metrology

- Low bending force
- Convenient routing

### Automation technology

- Large cable lengths
- Convenient routing
- High bending frequency
- Compact connecting elements

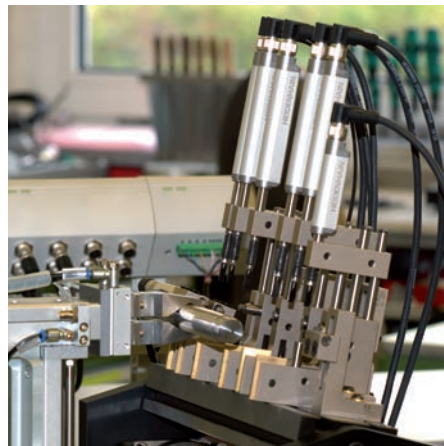

HEIDENHAIN cables and connecting elements are specially designed to meet the requirements of these areas of application. Functionality and durability are inspected through extensive testing.

Here are the advantages of HEIDENHAIN cables and connecting elements at a glance:

### Connecting elements

- Low transition resistance
- Reliable shield connection
- Continuous shielding throughout
- Corrosion-free contacts
- Reliable contact closure
- Long-term ruggedness

### Cables

- Low crosstalk
- Good shield coverage
- Small bend radius
- Suitable for drag chains
- Resistant to media
- Mechanically rugged
- Adapted wire cross section
- Resistant to aging

# Terminology for HEIDENHAIN pre-assembled cables

“Pre-assembled cable” is a hypernym referring to cables used for connecting devices such as a control and an encoder. Depending on which connecting elements are assembled at the ends, pre-assembled cables are divided into connecting, adapter, and output cables.

The length of a pre-assembled cable is the length of its insulated section between both connectors or cable ends. Please also note the specified cable length for output cables (see *Information on output cables*).

## VBK = Connecting cable



Cables that use the same type of connecting element at both ends, as well as cables with a free cable end, are referred to as connecting cables. This nomenclature applies regardless of whether the connecting elements are connectors or couplings and whether they are male or female, and so also applies to extension cables.

## Example

8-pin M12 connector with female contacts and an 8-pin M12 coupling with male contacts.



## APK = Adapter cable



Cables with different connecting elements at each end are referred to as adapter cables.

## Example

8-pin M12 connector with female contacts and a 15-pin D-sub connector with male contacts.



## AGK = Output cable



Output cables are assemblies that directly connect to the PCB connector of an encoder on one end and convert to a different connecting element system or a free cable end on the other.

## Example

Rotary encoder cable assemblies for use inside the motor housing; for conversion from a PCB connector to a 9-pin M23 angle flange socket.



# General information

## Durability and bending characteristics

### Versions

The output cables of nearly all HEIDENHAIN encoders, as well as the adapter cables and connecting cables, feature a **polyurethane (PUR)** jacket. Further materials used are **special elastomer (EPG)**, **special thermoplastic (TPE)**, and **polyvinylchloride (PVC)**. These cables are identified in the brochure as PUR, EPG, TPE, or PVC.

### Durability

**PUR cables** are oil-resistant in accordance with DIN EN 60811-404, as well as hydrolysis- and microbe-resistant in accordance with DIN EN 50363-10-2. They are free of PVC and silicone and comply with UL safety regulations. The **NRTL certification** is indicated by the following label: AWM STYLE 20963 80°C 30V.

**EPG cables** are suitable for higher temperature ranges and are oil-resistant in accordance with DIN EN 60811-404, as well as hydrolysis-resistant in accordance with DIN EN 50363-10-2, and are free of PVC and silicon. The jacket is free of halogen in accordance with IEC 60754-1. Compared with PUR cables, their resistance to media, frequent flexing, and continuous torsion is more limited.

**PVC cables** are oil-resistant. The NRTL certification is indicated by the following label: AWM STYLE 20789 105C VW-1SC NIKKO.

**TPE wires** in netting or heat shrink tubing are suitable for higher temperature ranges and low bending radii, but they exhibit only low oil-resistance.

### Bending characteristics

#### Temperature range\*

	Rigid configuration	Frequent flexing
PUR	-40 °C to 80 °C	-10 °C to 80 °C
EPG	-40 °C to 120 °C	-
TPE	-40 °C to 120 °C	-
PVC	-20 °C to 90 °C	-10 °C to 90 °C

\* Values may vary in individual cases

Some PUR cables can be used at temperatures of up to 100 °C, provided that the exposure to hydrolysis and media is low. If you need assistance, please contact HEIDENHAIN.

The **bend radii** of the cables differ based on whether they are used in a fixed installation or whether they are subjected to frequent flexing (e.g., in a drag chain). The minimum permissible bend radius is contingent on the cable diameter and cable jacket.

The **flexing frequency** of HEIDENHAIN cables is tested in continuous tests.

The **bending force** is a decisive criterion for applications in which no applied force is permitted (e.g., extremely fast or high-accuracy positioning tasks). The pre-assembled cable used for the connection between the stationary part and the moving part must therefore be highly flexible so as to prevent bending in the measuring setup due to the bending force of the cable. For such applications, HEIDENHAIN provides extremely thin cables with a bending force that is sufficiently low for frequent flexing.

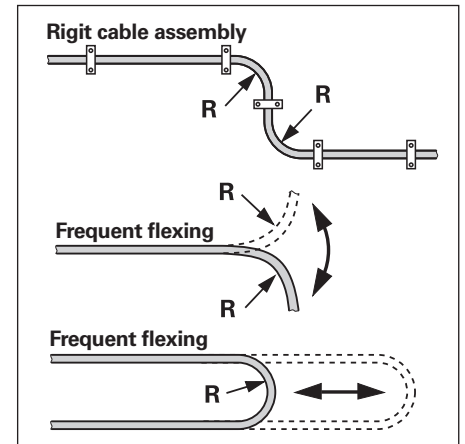

Cable	Material	Bend radius R at 20 °C	
		Rigid configuration	Frequent flexing
Ø 3.7 mm	EPG	≥ 10 mm	-
Ø 3.7 mm	PUR	≥ 8 mm	≥ 40 mm
Ø 4.3 mm		≥ 10 mm	≥ 50 mm
Ø 4.5 mm	EPG	≥ 18 mm	-
Ø 4.5 mm		≥ 10 mm	≥ 50 mm
Ø 5.1 mm	PUR	≥ 10 mm	≥ 50 mm
Ø 5.5 mm	PVC	Upon request	Upon request
Ø 6 mm	PUR	≥ 20 mm	≥ 75 mm
Ø 6.8 mm			
Ø 8 mm		≥ 40 mm	≥ 100 mm
Ø 10 mm <sup>1)</sup>		≥ 35 mm	≥ 75 mm
Ø 14 mm <sup>1)</sup>		≥ 100 mm	≥ 100 mm
6 or 8 TPE wires in netting or heat shrink tubing	TPE	≥ 10 mm	-
2 TPE wires in heat shrink tubing		≥ 3 mm	-
2 polyolefin wires in heat shrink tubing	Polyolefin in net sleeve	≥ 5 mm	-

<sup>1)</sup> Metal armor

## Electrical safety

The power provided to HEIDENHAIN encoders must be supplied from PELV systems (for a definition of terms, see EN 50178). The housings of HEIDENHAIN encoders are insulated from internal circuits. The rated surge voltage of the insulation is 500 V in accordance with EN 60664-1. In addition, contamination level 2 must be complied with in the micro-environment (see EN 60664-1).

## Electromagnetic compatibility

### Sources of electrical interference

Electrical interference is primarily caused by capacitive or inductive couplings. Interference can arise over wires and at input and output terminals on devices. Typical sources of electrical interference include the following:

- Strong magnetic fields from transformers, brakes, and electric motors
- Relays, contactors, and solenoid valves
- High-frequency equipment, pulse devices, and stray magnetic fields from switching power supplies
- Power cables and supply lines to the abovementioned devices

### Conformity

When the measures described below are fulfilled, HEIDENHAIN encoders comply with **EMC Directive 2014/30/EU** with regard to the generic standards for the following phenomena:

#### • Noise immunity (EN 61000-6-2)

Specifically, the following standards:

- ESD EN 61000-4-2
- Electromagnetic fields EN 61000-4-3
- Burst EN 61000-4-4
- Surge EN 61000-4-5
- Conducted disturbances EN 61000-4-6
- Power frequency magnetic fields EN 61000-4-8
- Voltage dips, short interruptions EN 61000-4-11

#### • Noise emission

**EN 61000-6-4**

### Measures

The EMC Directive requires the attainment of disturbance-free operation without the need for EMC expertise. The following measures serve to ensure this level of disturbance-free operation. If needed, please consult with HEIDENHAIN.

- Properly install or mount HEIDENHAIN encoders in accordance with the mounting instructions
- Use only original HEIDENHAIN cables. Comply with the maximum permissible cable lengths for the respective interface. For usage that deviates from standard usage (assignment of signals and connectors), the manufacturer of the complete system must ensure conformity

- Do not install signal cables in the direct vicinity of sources of interference (inductive consumers such as contactors, motors, frequency inverters, solenoids, etc.)
  - Sufficient decoupling from interference-signal-conducting cables can usually be achieved by an air clearance of 100 mm or, when cables are routed in metal ducts, by a grounded partition
  - A minimum clearance of 200 mm to storage reactors in switching power supplies is required
- Prevent accidental contact between the shield (e.g., connector) and other metal parts
- For cables with an internal shield and external shield, connect the internal shield to 0 V on the subsequent electronics (exception: the hybrid motor cable from HEIDENHAIN; see the documentation on the hybrid motor cable). Do not connect the internal shield with the external shield
- Use connecting elements (e.g., connectors or terminal boxes) with metal housings. These connecting elements may be used only for the signals and supply voltage of the connected encoder (exception: the hybrid motor cable from HEIDENHAIN)
- Connect the encoder housing, connecting elements, and subsequent electronics with each other by means of the cable shield. Connect the shield over a large area along the complete circumference (360°). For encoders with more than one electrical connection, refer to the documentation for the respective product
- Install encoders and interface electronics with exposed electronics or a plastic housing in an enclosed metal housing. If other signals and sources of interference will pass through the housing, then EMC expertise is required, and the manufacturer of the complete system must ensure conformity
- Connect the (external) shield with functional earth in accordance with the mounting instructions
- For devices and cable assemblies with plastic connectors or connectors without a large-area shield connection, connect the (external) shield with functional earth over a large area just a short distance prior to the connector (shield clamp; see figure). There must be no source of interference in the immediate vicinity
- For encoders that optionally enable the connection of an external sensor (e.g., a temperature sensor), conformity with the EMC Directive applies only to operation without an external sensor. For operation with an external sensor (e.g., temperature sensor), EMC expertise is required for disturbance-free operation, and the manufacturer of the complete system must ensure conformity
  - In most applications, disturbance-free operation is possible because the disturbances acting on the sensor are low
  - In addition, the requirements for the electrical isolation of the sensor must be considered, because electrical hazards can arise in such systems
- If compensating currents are to be expected within the complete system, then a separate equipotential bonding conductor must be provided. The shielding does not serve the function of an equipotential bonding conductor
- For HEIDENHAIN encoders, provide high-frequency, low-resistance grounding (see the EMC chapter in EN 60204-01)

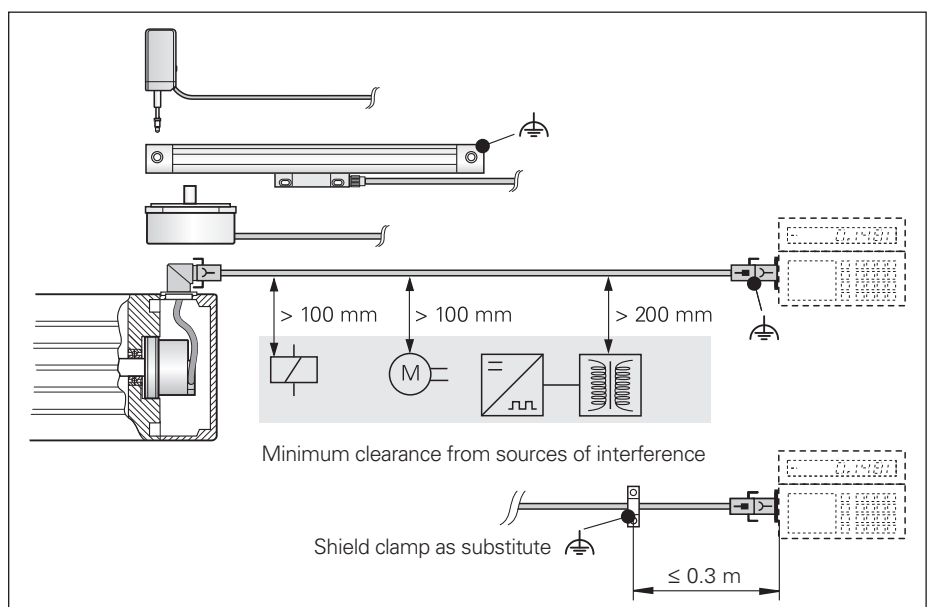

# Information on output cables

Mounting and commissioning must be performed only with appropriate ESD protection. Do not engage or disengage the connecting element when it is under power. To avoid overstressing the individual wires during disengagement of a connecting element, HEIDENHAIN recommends that you use the mounting aid for disconnecting the PCB connector.



Mounting aid for PCB connector

## Screws

For output cables with standard M12 or M23 flange sockets, use M2.5 screws.

The mounting method with M2.5 screws was designed for the following tightening torques:

For M12, M23:  $M_d$  min. 0.4 Nm  
 $M_d$  max. 0.5 Nm

Load-bearing thread length: At least 4 mm  
 Min. tensile strength of screws: 800 N/mm<sup>2</sup>

To prevent the screws from loosening on their own, HEIDENHAIN recommends the use of a material bonding threadlocker.

## Cable length (rated length)

For output cables with crimping on the encoder side for strain relief and shield contacting, the specified cable length applies up to the crimp sleeve.

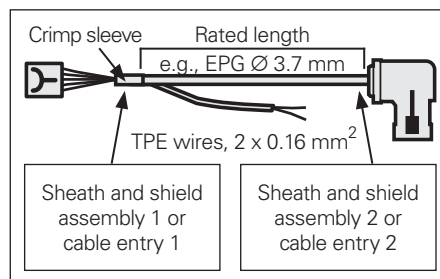

The rated wire length for temperature sensors is the same as the rated cable length for standard output cables. Exceptions apply to output cables without crimping on the encoder side or to a shield connection clamp. You can receive binding information (a dimension drawing) upon request based on the ID number of the given output cable (see *Cable list*).

## Electromagnetic compatibility

Cables from HEIDENHAIN are tested for electromagnetic compatibility. For output cables with wires for temperature sensors, conformity with the EMC Directive in the complete system must be documented.

## Crimp connector

For joining (crimping) the wires of the temperature-sensor output cable to the wires of the temperature sensor within the motor housing.

ID 1148157-01

For information on the appropriate crimping tools, please refer to the *HMC 6* Product Information document.

## Strain relief

Avoid torque or tensile stress, and use strain relief whenever necessary.

## Straight M12 flange socket

Retention force of polarizing key: max. 1 Nm.

## Accessory

**Mounting aid** for disengaging the PCB connector. Suitable for all modular rotary encoders for electric motors (except for those of the ERO 1200 series). ID 1075573-01

To avoid damage to the cable, apply pulling force only to the connector and never to the wires.



# General testing accessories for modular encoders and the PWM 21

## Testing cable for modular rotary encoders with the EnDat22, EnDat01, SSI, and DRIVE-CLiQ interfaces

Includes three 12-pin adapter connectors and three 15-pin adapter connectors.  
ID 621742-01

### Adapter connectors

Three connectors for replacement.  
12-pin: ID 528694-01  
15-pin: ID 528694-02

## Connecting cable for the EnDat22, EnDat01, and SSI interfaces

For extending the testing cable;  
completely assembled with a 15-pin D-sub connector (male) and a 15-pin D-sub connector (female), max. 3 m.  
ID 1080091-xx

## Adapter cable for DRIVE-CLiQ Ø 6.8 mm

15-pin D-sub (female) and  
6-pin RJ45 Ethernet connector  
with IP20 metal housing.  
ID 1228399-01

## Testing cable for the ERN 138xx, with commutation signals for sinusoidal commutation

Includes three 14-pin adapter connectors.  
ID 1118892-02

### Adapter connectors

Three 14-pin connectors for replacement.  
ID 528694-04

## Adapter cables for connecting the flange socket on the motor to the PWM 21

### For the EnDat22 interface, adapter cable Ø 6 mm

9-pin M23 connector (female) and  
8-pin M12 coupling (male).  
ID 1136863-xx  
(ID 524599-xx is additionally required:  
15-pin M12 (female) and  
15-pin D-sub connector (male))

### Adapter cables Ø 6 mm/8 mm

8-pin M12 connector (female) and  
15-pin D-sub connector (male).  
ID 1036526-xx Ø 6 mm  
ID 1129753-xx Ø 8 mm

### For the DRIVE-CLiQ interface, adapter cable Ø 6.8 mm

9-pin M23 connector (female) and  
6-pin RJ45 Ethernet connector  
with IP20 metal housing.  
ID 1117540-xx

### Adapter cable Ø 6.8 mm

8-pin M12 connector (female) and  
6-pin RJ45 Ethernet connector  
with IP20 metal housing.  
ID 1093042-xx

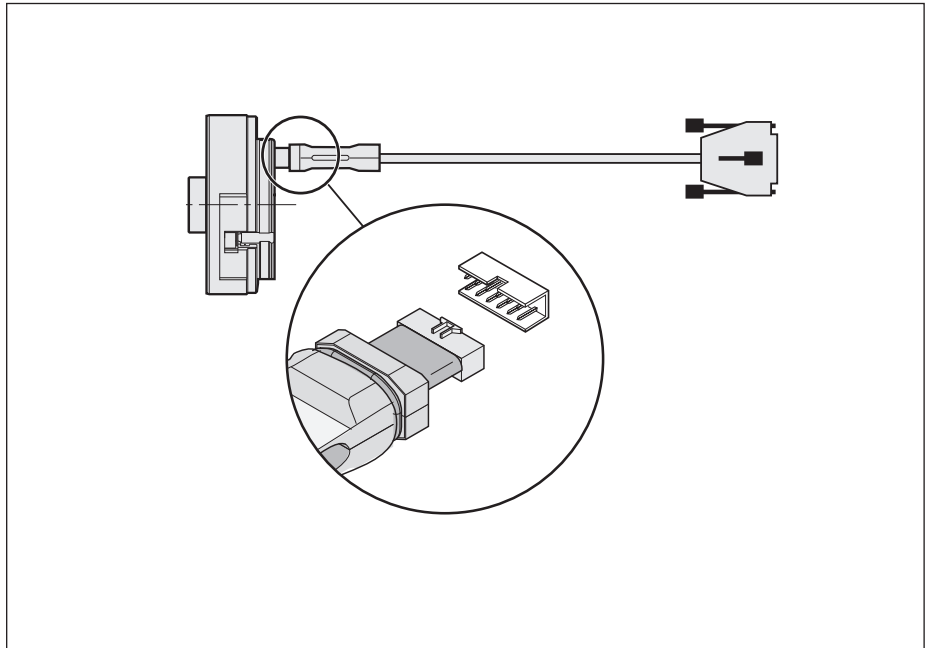

Testing cable for modular rotary encoders

### Connecting cable

For extending the testing cable  
Completely assembled with 15-pin  
D-sub connector (male) and 15-pin  
D-sub connector (female), max. 3 m.  
ID 675582-xx

### For EnDat01, EnDat Hx, EnDat Tx, or SSI interface with incremental signals, adapter cable Ø 8 mm

17-pin M23 connector (female) and  
15-pin D-sub connector (male).  
ID 324544-xx

### Adapter cable Ø 8 mm

12-pin M23 connector (female) and  
15-pin D-sub connector (male).  
ID 310196-xx

### Version for HMC 6, adapter cable Ø 13.6 mm

M23 SpeedTEC hybrid connector (female),  
with five power wires, two brake wires,  
and six communication wires, and  
15-pin D-sub connector (male).  
ID 1189174-xx

DRIVE-CLiQ is a registered trademark of  
Siemens AG.

SpeedTEC is a registered trademark of  
TE Connectivity Industrial GmbH.

# Usage in drag chains

## Encoder cables in drag chains

When properly routed, encoder cables from HEIDENHAIN are suitable for use in drag chains. These cables feature a typical service life of five to ten million cycles. A key factor for attaining this service life is compliance with the drag chain manufacturer's routing instructions and the routing information provided below. Incorrect routing or non-compliance with the routing instructions can significantly reduce the service life of the cables.

## Information for routing in drag chains

When used in drag chains, encoder cables are subjected to extremely high mechanical loads. The higher the traversing speed or number of cycles, the more stringently the routing instructions must be adhered to.

Routing information for the cable arrangement:

- Cables should be routed separately. As this is not always possible due to lack of space, cables with identical or similar diameters can be routed next to each other within the same compartment. Cables with widely varying diameters or cables made of different materials must be separated by vertical and horizontal separators.
- The cables must not be permitted to shift over each other. In order to prevent such shifting, the clearance height of a compartment within the drag chain must not be greater than half of the cable diameter.
- The space provided for the cables must be at least 10 % to 20 % of the cable diameter. This ensures the required freedom of movement for the cable.

General routing information:

- The cables must be routed without twists. Unwind the cables from any drums or rings beforehand.
- The cables must be able to move freely within the chain radius. Do not route the cables too tightly together or over an excessive distance.
- Provide strain relief on both ends of each cable. Be sure to clamp it over as large an area as possible.
- The weight should be distributed as evenly as possible in relation to the chain width.

Routing information for bend radii:

- The minimum permissible bend radius of the chain is determined based on the permissible bend radius of all cables.
- A bend radius that is larger than the minimum bend radius of the cable positively affects the service life of the cable. The bend radius should be chosen accordingly.

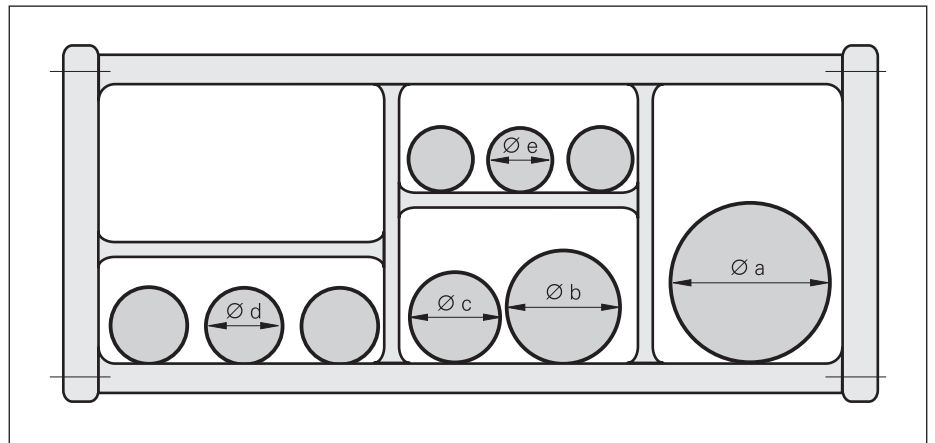

Configuration of a drag chain with cables of varying diameters ( $\varnothing x$ )

# Cable lengths

## Maximum cable lengths

The cable lengths defined in the specifications and in the *Interfaces of HEIDENHAIN Encoders* brochure apply only to HEIDENHAIN cables and to the recommended input circuits of the subsequent electronics.

The maximum attainable cable length is limited by the following key factors:

- Compliance with the supply voltage at the encoder
- Influence of the supply voltage of the subsequent electronics
- Restrictions arising from the transmission technology (e.g., protocol design for purely serial interfaces and manufacturer specifications for proprietary interfaces)

Please note: These restrictions must be checked independently from each other and complied with.

## Compliance with the supply voltage at the encoder

The interfaces of HEIDENHAIN encoders permit large cable lengths of up to 150 m. Over large cable lengths, the voltage drop in the supply wires is considerable. The voltage drop is influenced by the cable length, the current consumption of the encoder, and the wire cross-section of the supply lines.

The voltage drop may cause the supply voltage to fall below its minimum permissible level, particularly in the case of large cable lengths and encoders with high current requirements, such as absolute linear and angle encoders. The highest possible supply voltage  $U_P$  should therefore be selected in the subsequent electronics. The voltage drop can be mitigated through the following measures:

- Keep thin cables with small wire cross-sections as short as possible
- For large cable lengths, use a wider wire cross section
- For subsequent electronics without a variable power supply unit, connect the sense lines in parallel with the supply lines. This doubles the available cross-section

## Data transfer technology

The transmission characteristics of the pre-assembled cables, protocol properties of the interfaces, and other specifications impose limitations on the design of the cable lengths.

Purely serial interfaces with transmission frequencies of up to 16 MHz, in combination with large cable lengths, place high technological demands on the cable. Thanks to a design that is specially adapted to these applications, HEIDENHAIN cables are highly suitable for meeting these requirements. For this reason, HEIDENHAIN recommends using original HEIDENHAIN cables.

An adapter cable connected directly to the encoder is limited in terms of its length. To implement larger cable lengths, an adapter cable and an additional connecting cable with a larger cross section can be used.

## Lengths of pre-assembled cables

The maximum overall length of the pre-assembled cables is provided in the table below.

EnDat 2.2	100 m
DRIVE-CLiQ	100 m
Fanuc, Panasonic	30 m <sup>1)</sup>
Mitsubishi, Yaskawa	30 m
EnDat 2.1	150 m
SSI	100 m
1 V <sub>PP</sub>	150 m
11 μA <sub>PP</sub>	30 m
TTL	100 m

<sup>1)</sup> Lengths of up to 50 m are possible depending on the encoder

Further information, particularly on the TTL and EnDat interfaces, can be found in the *Interfaces of HEIDENHAIN Encoders* brochure. Please consider the *Specifications* of the given encoder.

Based on the interface and cable diameter used, the following restrictions must be considered:

## EnDat 2.1, SSI, 1 V<sub>PP</sub>, and TTL interfaces:

- Adapter cables for connection to the encoder are possible up to a length of 9 m

## EnDat 2.2, Fanuc, Mitsubishi, Panasonic, and Yaskawa purely serial interfaces:

In order to meet the growing demands placed on transmission technology in the future, suitable cables have been introduced for purely serial interfaces. These cables feature the following key advantages over the cables used up to now:

- Optimized transmission characteristics for future requirements
- Optimized suitability for use in drag chains

In order to attain these characteristics, the cable design and the cross sections of the wires within the cable have been adapted accordingly. This change in the cross sections of the supply wires must be considered during the design phase, particularly when large cable lengths are involved.

The diameter of the adapter cables and connecting cables is a determining factor for the maximum cable length (see *Figure 1 on page 14*).

Typical overall lengths of 30 m are attainable without restrictions. For larger overall lengths, connecting cables with a larger cross section must be used or, if possible, the supply voltage of the subsequent electronics  $U_P$  should be increased.

**DRIVE-CLiQ** interface:

DRIVE-CLiQ permits a maximum cable length of 100 m, but this value is reduced by a number of factors:

- Number of dividing points with DRIVE-CLiQ couplings
- Length factor of the pre-assembled cables
- Pluggable pre-assembled cable at the HEIDENHAIN encoder
- Length of the HEIDENHAIN pre-assembled cable with compensation factor
- Output cable (AGK)

Encoders connected via an output cable (AGK) have an additional length limitation. Due to the transmission characteristics of the output cable (AGK), a limit value of 40 m applies to the formula for calculating the maximum permissible cable length. This limitation applies to all output cables (AGK) that are indicated with "DQ01" in the "Use with" column in the cable overviews.

**Note:**

Depending on the encoder, further length restrictions may apply. For more information, see the brochure or Product Information document of the given encoder.

**Permissible length of the pre-assembled cable for DRIVE-CLiQ**

The maximum permissible cable length is calculated as follows:

$$n_{MG} \cdot 2 \text{ m} + \frac{4}{3} \cdot L_{AK} + \sum_i k_i \cdot L_i + n_C \cdot 5 \text{ m} \leq 100 \text{ m}$$

$k_i$ : Length compensation factor<sup>1)</sup> of the signal line  $i$  (4/3 for cables from HEIDENHAIN)

$L_i$ : Overall length<sup>1)</sup> of the signal line  $i$

$n_C$ : Number of dividing points

$n_{MG}$ : Influence of the encoder (e.g., for a pluggable adapter cable;  $n = 1$ )

4/3: Length compensation factor for HEIDENHAIN pre-assembled cables

$L_{AK}$ : Length of the HEIDENHAIN pre-assembled cable

<sup>1)</sup> See the technical documentation of the subsequent electronics manufacturer

## Power supply

The voltage values must be maintained at the encoder. The voltage at the encoder can be monitored and adjusted as needed via the **sense lines**, if present. If a variable power supply unit is not available, then the voltage drop can be reduced by connecting the sense lines in parallel with the corresponding supply wires.

The voltage  $U_P$  actually applied at the encoder is to be considered when **calculating the current consumption and power consumption of the encoder**. This voltage is the supply voltage  $U_E$ , which is provided by the subsequent electronics, minus the **voltage drop  $\Delta U$**  on the supply wires.

For **encoders without an extended power supply range** (typical supply voltage: DC 5 V), the voltage drop  $\Delta U$  on the supply wires is calculated as follows:

$$\Delta U = 2 \cdot \frac{1.05 \cdot L_K}{56 \cdot A_P} \cdot I_M \cdot 10^{-3}$$

For **encoders with an extended power supply range**, the calculation of the voltage drop  $\Delta U$  on the supply wires must account for the non-linear current consumption. This is done in three steps:

### Step 1: Resistance of the supply wires

The resistance of the supply wires (adapter cable and connecting cable) can be calculated with the following formula:

$$R_L = 2 \cdot \frac{1.05 \cdot L_K}{56 \cdot A_P}$$

### Step 2: Coefficients for calculation of the voltage drop

$$b = R_L \cdot \frac{P_{Mmax} - P_{Mmin}}{U_{Pmax} - U_{Pmin}} + U_E$$

$$c = P_{Mmin} \cdot R_L + \frac{P_{Mmax} - P_{Mmin}}{U_{Pmax} - U_{Pmin}} \cdot R_L \cdot (U_E - U_{Pmin})$$

### Step 3: Voltage drop based on the coefficients b and c

$$\Delta U = 0.5 \cdot (b - \sqrt{b^2 - 4 \cdot c})$$

If the value of the voltage drop  $\Delta U$  is known, then it is possible to calculate the following parameters for the encoder and subsequent electronics: the voltage at the encoder, the current consumption and power consumption of the encoder, and the power to be provided by the subsequent electronics.

Voltage at the encoder:

$$U_P = U_E - \Delta U$$

Current consumption of the encoder:

$$I_M = \frac{\Delta U}{R_L}$$

Power consumption of the encoder:

$$P_M = U_P \cdot I_M$$

Power output of the subsequent electronics:

$$P_E = U_E \cdot I_M$$

If an encoder is operated with subsequent electronics via **interface electronics**, then the power consumption of the encoder and that of the interface electronics must be added together in order to calculate the resulting power consumption.

Depending on the interface electronics, a compensation factor for the efficiency of the interface electronics' switched mode power supply (see the respective Product Information document) may have to be taken into account.

HEIDENHAIN encoders with a DRIVE-CLiQ interface are designed for a rated voltage of DC 24 V. The subsequent electronics manufacturer specifies DC 20.4 V to 28.8 V as the tolerance for the supply voltage. A larger voltage range is possible as well (see *Specifications*). Operation is briefly permissible at up to DC 36.0 V. In the range of DC 28.8 V to 36.0 V, a higher power consumption is to be expected.

Definitions:

$U_P$  Voltage at the encoder in V

$I_M$  Current consumption of the encoder in mA

$P_M$  Power consumption of the encoder in W

$U_E$  Supply voltage of the subsequent electronics in V

$P_E$  Power output of the subsequent electronics in W

$\Delta U$  Voltage drop in the cable in V

$L_K$  Cable length in meters

$A_P$  Cross section of the supply wires in  $\text{mm}^2$  (see *Cables*)

2 Outgoing and incoming lines

1.05 Length factor due to twisted wires

56 Electrical conductivity of copper

$R_L$  Resistance of the supply wires (for both directions) in ohms

$P_{Mmin}$ ,

$P_{Mmax}$  Maximum power consumption in W at minimum and maximum supply voltage

$U_{Pmin}$ ,

$U_{Pmax}$  Minimum or maximum supply voltage of the encoder in V

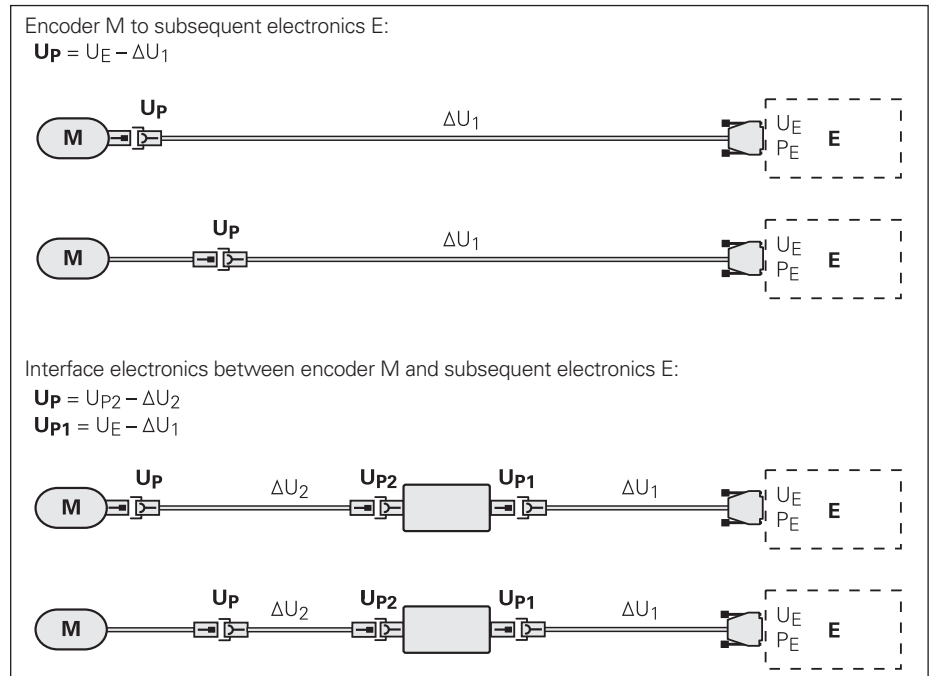

Encoder	Power consumption at $U_P = 3.6\text{ V}$ or $14\text{ V}$	Adapter cable $\varnothing 4.5\text{ mm}$ $A_P = 2 \times 0.16\text{ mm}^2$	Pre-assembled cable $\varnothing 6\text{ mm}$ $A_P = 2 \times 0.16\text{ mm}^2$	Pre-assembled cable $\varnothing 8\text{ mm}$ $A_P = 2 \times 0.35\text{ mm}^2$	
LC RCN ROC	$3.6\text{ V} \leq 1100\text{ mW}$ $14\text{ V} \leq 1300\text{ mW}$	20 m 6 m 1 m	15 m 29 m 34 m	35 m 66 m 77 m	
ECN 1325	$3.6\text{ V} \leq 600\text{ mW}$ $14\text{ V} \leq 700\text{ mW}$	0.3 m	Output cable inside the motor housing	65 m	99 m
EQN 1337	$3.6\text{ V} \leq 700\text{ mW}$ $14\text{ V} \leq 800\text{ mW}$	0.3 m		55 m	99 m
AK LIC 41x	$3.6\text{ V} \leq 950\text{ mW}$ $14\text{ V} \leq 1050\text{ mW}$	3 m 1 m	Output cable on the encoder	37 m 39 m	85 m 89 m

Maximum cable length for purely serial interfaces (determined based on a supply voltage of DC 4.9V)

A major factor influencing the attainable maximum cable length is the supply voltage of the subsequent electronics. The value selected for the table, 4.9V, represents the lower limit of the supply voltage of commercially available subsequent electronics. The table shows examples of adapter cable length combinations (with a diameter of 4.5 mm) for various encoders and the resulting maximum cable lengths of the connecting cable. The values in the table apply to a parallel connection of the sense lines and the supply lines. The attainable overall length is the sum of the lengths of the adapter cable and connecting cable.

Remarks:

- The values are valid for a supply voltage of  $U_P = 4.9\text{ V}$  of the subsequent electronics
- Cable lengths may be limited depending on the interface version of the encoder (see the encoder data in the respective brochure; maximum value = 100 m)
- The power consumption values stated here apply only to the current edition of the *Cables and Connectors* brochure. For the currently valid power consumption values, please refer to the specifications in the relevant product brochure
- Please also consider the information provided by the subsequent electronics manufacturer regarding the supply voltage for the encoder and the maximum permissible cable lengths

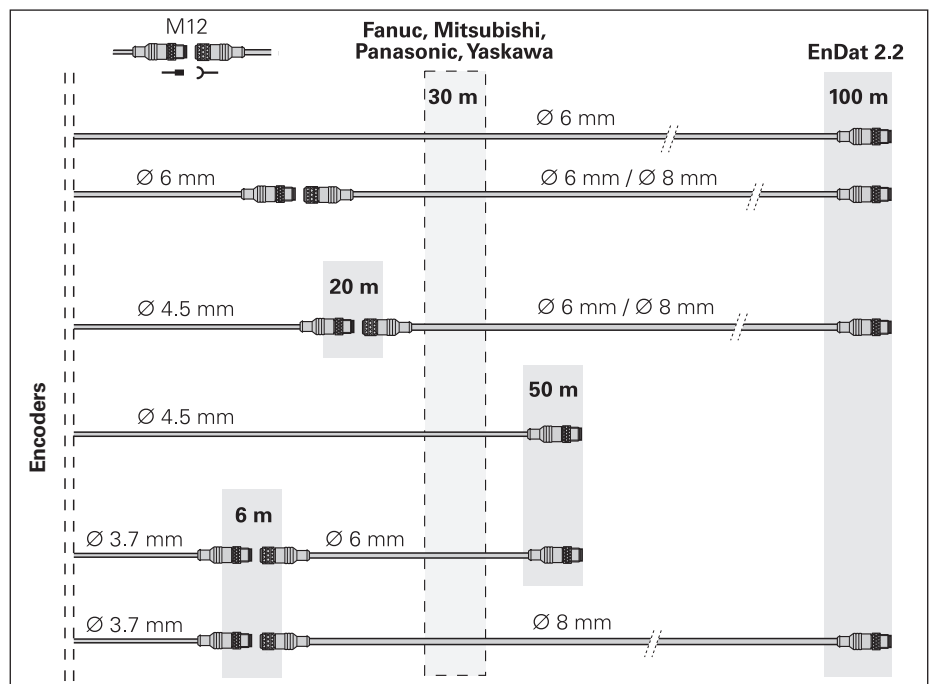

Figure 1: Cable lengths for purely serial interfaces

# Connecting elements on HEIDENHAIN cables

## Overview of connecting elements

Connecting elements are subdivided into the following:

Connectors  
(with coupling ring)



Couplings  
(with external thread)



Please note: When tightening the M12 connectors, adhere to a torque of 0.6 Nm to 0.8 Nm. A torque wrench is separately available. The pre-assembled cable with an M12 connector (female) comes with an insulator for preventing electrical contact

with other electrically conductive parts. After the connecting element has been tightened, the insulator must be inserted such that the inside wall lies between the knurled nuts.

**Plastic-insulated connectors:** connecting elements with coupling ring

**M12**

**M23**

**M12 right-angle connector**

**Quick connectors**  
M12, on the adapter cable

\* Cable fastening

**Compact connector with push-pull lock**

**M12 right-angle connector (side view)**

**Plastic-insulated couplings:** connecting element with external thread

**M12**

**M23**

**Coupling on the adapter cable**

**14-pin M12**

**Mounted coupling with flange**

**M23**

**Mounted coupling with central fastening**

**M23**

mm  
  
 Tolerancing ISO 8015  
 ISO 2768 - m H  
 ≤ 6 mm: ±0.2 mm

Length of injection-molded connecting elements: ±2.5 mm

**Flange socket:** with external thread; is fastened to a housing

**M23**

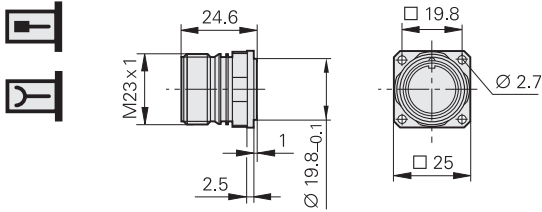

**Flange socket:** with output cable for inside the motor housing; for the EnDat21/22 interface

**M12**

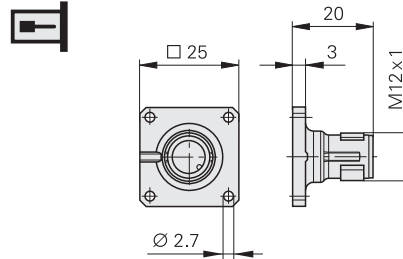

**Angle flange socket** (rotatable): with output cable for inside the motor housing

**M23**

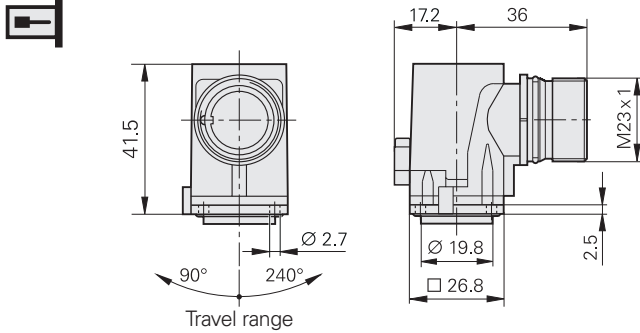

**Flange socket:** with output cable for inside the motor housing; for the DRIVE-CLiQ interface

**M12**

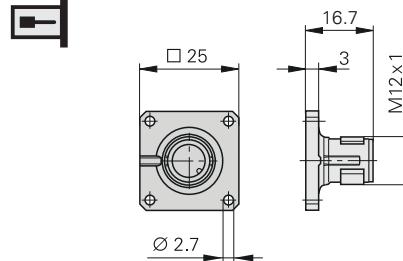

**Angle flange socket** SpeedTEC (rotatable): with output cable for inside the motor housing

**M23**

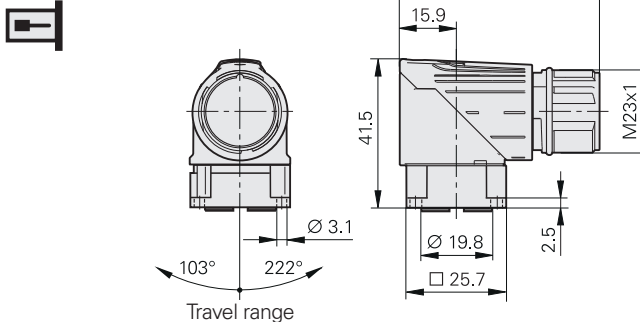

Output cables with a SpeedTEC angle flange socket always come with a mounted O-ring for vibration protection. As a result, they can be used as connecting cables (VBK) with either a threaded connector (with O-ring) or a SpeedTEC connector (O-ring needs to be removed).

SpeedTEC is a registered trademark of TE Connectivity Industrial GmbH.

**Required mating dimensions for M12 and M23 flange sockets**

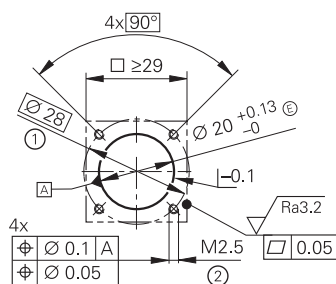

1 = Bolt circle diameter  
2 = At least 4 mm of load-bearing thread

mm  
Tolerancing ISO 8015  
ISO 2768 - m H  
≤ 6 mm: ±0.2 mm



## HMC 6

### Flange socket

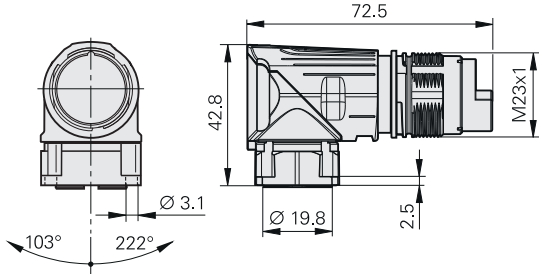

### Required mating dimensions for flange socket

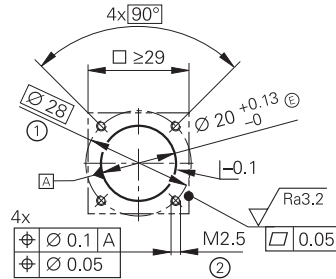

- 1 = Bolt circle diameter  
2 = At least 4 mm of load-bearing thread

### Connector

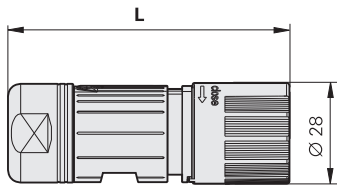

	L
Ø 9.5 mm – Ø 14.5 mm	78
Ø 14 mm – Ø 17 mm	80.5

### Coupling

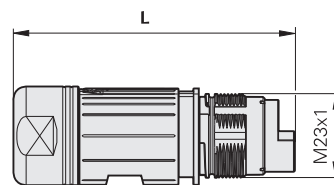

	L
Ø 9.5 mm – Ø 14.5 mm	78
Ø 14 mm – Ø 17 mm	80.5

## D-sub connector for HEIDENHAIN controls and subsequent electronics

### Symbols

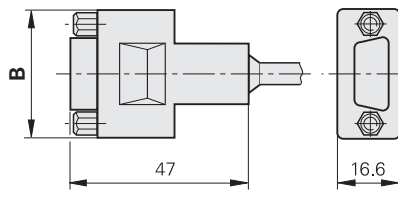
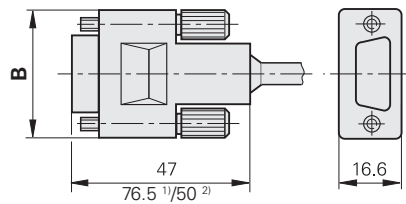

- 1) Interface electronics integrated into the connector  
2) Design A, partially with integrated interface electronics

Number of pins	B
9	35
15	43
25	56

The **pin numbering** on connectors is in the direction opposite to that on couplings or flange sockets, regardless of whether the connecting elements have

male contacts or



female contacts.



When engaged, the connections provide **protection** up to IP67 (D-sub connector: IP50; EN 60529). When not engaged, there is no protection.

### Accessories for flange sockets and M23 mounted couplings

#### Threaded metal dust cap

ID 219926-01

#### Gasket

ID 266526-01

mm



Tolerancing ISO 8015

ISO 2768 - m H

≤ 6 mm: ±0.2 mm

# Hybrid cable technology from HEIDENHAIN

## Single-cable solution for servomotors

Servomotors normally require two separate cables:

- one cable for the motor encoder, and
- one cable for the motor power supply.

With the **HMC 6** (Hybrid Motor Cable), HEIDENHAIN has integrated the encoder wires into the power cable. Thus, only **a single cable** is needed between the motor and electrical cabinet.

The HMC 6 single-cable solution has been specially designed for the HEIDENHAIN **EnDat 2.2** interface, featuring purely serial transmission (ordering designation: EnDat22) over cable lengths of up to 100 m. However, any encoder with a purely serial RS-485 interface can be connected as well. A wide range of encoders can therefore be used without a new interface needing to be introduced. Rotary encoders with buffer battery backup are currently in development.

The HMC 6 solution combines the wires for the encoder, motor, and brake all within a single cable. This cable is connected to the motor via a special connector. For connection to the inverter, the cable is split into power connections, brake connections, and an encoder connector, so that all of the previous components can continue to be used on the control.

When the components are correctly mounted, the connecting elements attain an IP67 rating. The connector incorporates a quick-release lock as well as vibration protection against the loosening of coupling joints.

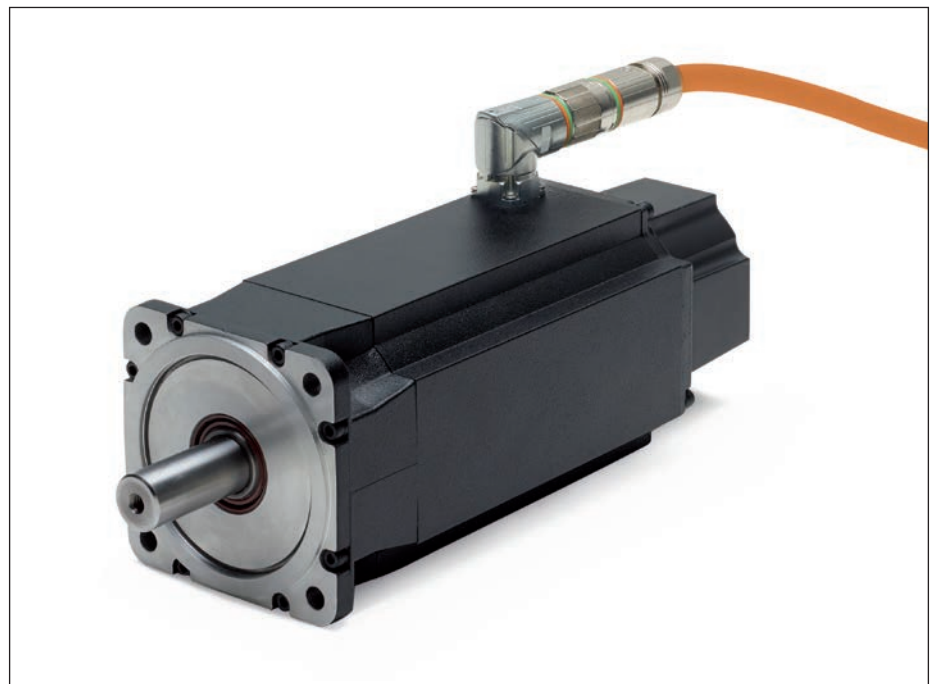
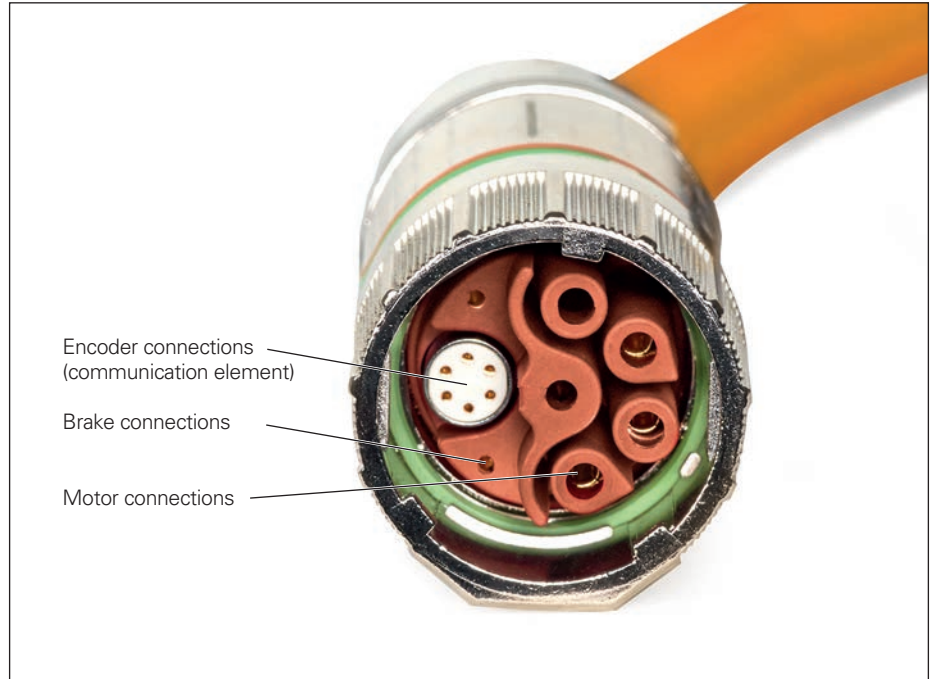

### Advantages

The HMC 6 single-cable solution offers a series of cost and quality benefits for both the motor maker and the machine manufacturer:

- Continued utilization of existing interfaces
- Usability with more compact drag chains
- Significant improvement in drag-chain suitability thanks to fewer cables
- Wide selection of available encoders for HMC 6 transmission
- Reduced mechanical requirements (flange socket on the motor, cable ducts in the machine housing)
- Reduced logistical cost and effort for cables and connectors
- Simpler and faster installation
- Reduced documentation effort
- Fewer servicing components required
- Smaller motor profile with attached cable, and thus easier integration into the machine housing
- HEIDENHAIN-tested combination of a power and encoder cable

The universal design of the HMC 6 gives you, the motor or machine manufacturer, utmost flexibility, allowing you to use standard components on both the motor and the control.

A particular advantage of the HMC 6 single-cable solution is its compatibility with **all HEIDENHAIN encoders equipped with the EnDat interface** (ordering designation EnDat22) and those capable of purely serial data transmission in accordance with RS-485. Compatible encoders include rotary encoders for servomotors in various sizes, as well as linear and angle encoders used in direct drives. Also compatible, of course, are encoders for **functional safety** up to SIL 3. Rotary encoders with buffer battery backup are currently in development.

But there is no need for acrobatics on the control side either, because you can continue to use your already existing inverter systems or controller units. The HMC 6 cable is designed for easy assembly of the required connecting elements. Importantly, this does not impair its noise immunity.



### Components

You need only a few components in order to prepare your motor for the single-cable solution.

### Connecting element on the motor

The motor housing must be equipped with a special angle flange socket, bringing together the wires for the encoder, the motor power supply, and the brake.

### Crimping tools for the power wires

The crimp contacts for the power and brake wires are assembled with the usual tools.

### Output cables inside the motor housing

The rotary encoder is connected via the output cable inside the motor housing—you then simply plug your pre-assembled communication element into the angle flange socket.

### Cable with hybrid connector

In addition to the encoder wires, the HMC 6 motor connecting cable also incorporates the power and brake wires. The cable is assembled with a hybrid connector on one end.

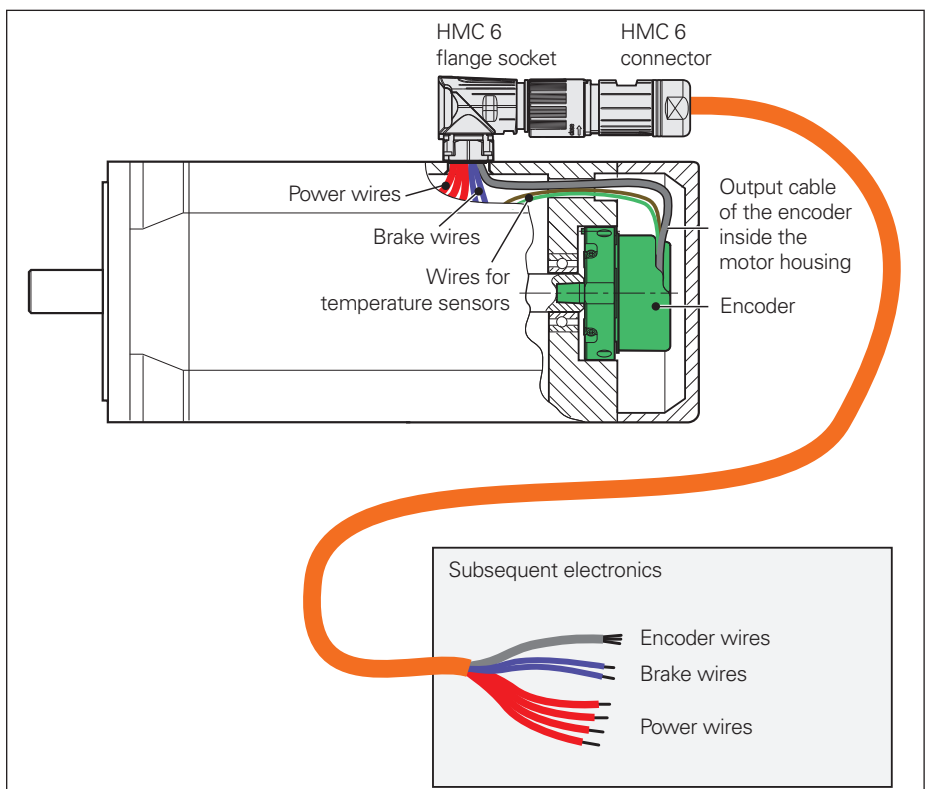

**Further information:**

HMC 6 Product information document.

# Cable overviews

## Notes on the cable overviews

### Layout of the cable overviews

On the left, the cable overviews depict the devices with their pre-assembled cables leading to the subsequent electronics. In between, various connecting elements or

interface electronics may be used. The subsequent electronics are listed on the right. They are grouped based on their pin layout and differentiated by their connecting element.

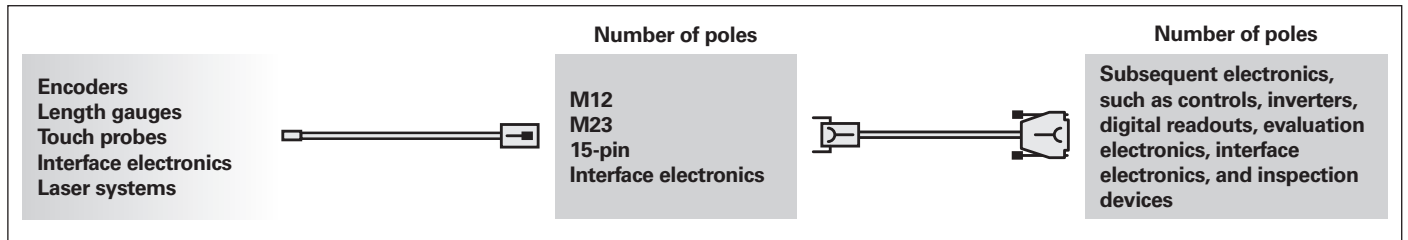

Schematic representation of cable overviews

### Example of a cable configuration:

Connection of an RCN with a TNC in a machine tool under the following circumstances:



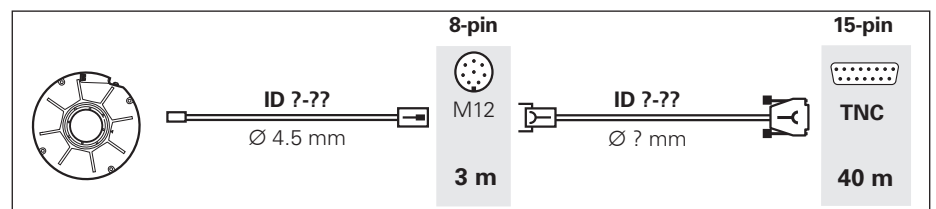



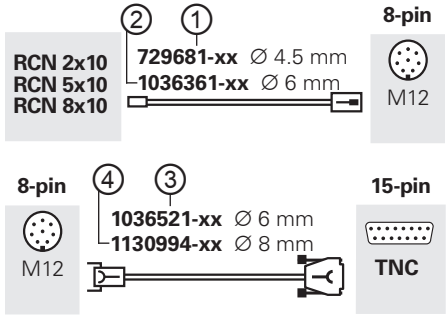
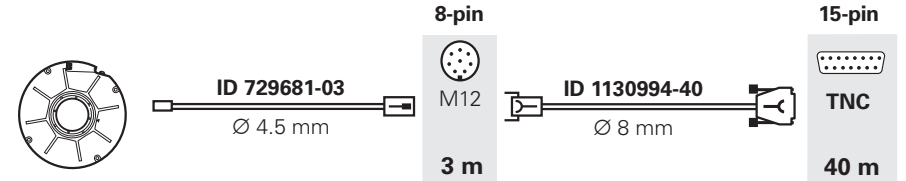









- RCN 5310:
  - Interface: EnDat 2.2
  - Ordering designation: EnDat22
  - Extended supply voltage range:
    - $U_{Pmin} = 3.6 \text{ V}$  (power consumption:  $P_{Mmin} \leq 1100 \text{ mW}$ )
    - $U_{Pmax} = 14 \text{ V}$  (power consumption:  $P_{Mmax} \leq 1300 \text{ mW}$ )
- Adapter cable (APK) for the connection on the encoder:
  - Cable length:  $L_{K1} = 3 \text{ m}$ ;  $\varnothing 4.5 \text{ mm}$
- M12 connecting element at the transition to the drag chain
- Adapter cable (APK) for the control:
  - Cable length:  $L_{K2} = 40 \text{ m}$
- TNC 640:
  - Encoder input: 15-pin D-sub
  - Supply voltage:  $U_E \text{ min. } 4.9 \text{ V}$
  - Sense lines are additionally used for the power supply

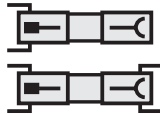

The following example illustrates the use of the cable overviews, cable list, and pin layouts.

<p>Select the appropriate cable overview based on the desired interface and the ordering designation of the encoder.</p>	<p>"Adapter cables and connecting cables for EnDat interface (EnDat22)"</p>
<p>Determine the ID number of the cable (in some cases, multiple ID numbers are possible). Pay attention to the correct cable configuration, connecting element, and number of pins!</p>	 <p>An APK with <math>\varnothing 4.5</math> mm is needed, so the cable ① is selected</p> <p>Cables with <math>\varnothing 6</math> mm and <math>\varnothing 8</math> mm are possible, so cables ③ and ④ can be used</p>
<p>Determine the permissible cable length for signal transmission (see <i>Cable lengths</i>). Observe the restrictions regarding the adapter cable for connection to the encoder!</p>	<p>EnDat 2.2 interface:          3 m APK <math>\varnothing 4.5</math> mm on RCN <math>\leq 20</math> m ✓          43 m overall length <math>\leq 100</math> m ✓</p>
<p>To calculate the voltage drop, look up the cross section of the supply wires in the cable list.</p>	<p>729681-xx and 1036521-xx: <math>A_P = 2 \times 0.16 \text{ mm}^2</math>          1130994-xx: <math>A_P = 2 \times 0.35 \text{ mm}^2</math></p>
<p>Check for compliance with the supply voltage (see <i>Cable lengths</i>). Each combination of cables must be calculated separately.</p>	<p>The maximum permissible voltage drop is calculated based on the information regarding the encoder and control:  <math>\Delta U_{\max} = U_E - U_P = 4.9 \text{ V} - 3.6 \text{ V} = 1.3 \text{ V}</math></p>
<p>Calculate the resistance of the supply wires</p> $R_L = 2 \frac{1.05 \cdot L_K}{56 \cdot A_P}$ <p>Add together the total resistance of both cables</p>	<p>① <math>R_L = 0.402 \Omega</math>          ③ <math>R_L = 4.69 \Omega</math>          ④ <math>R_L = 2.14 \Omega</math></p> <p>Total resistance          ①/③ <math>R_L = 5.0 \Omega</math>          ①/④ <math>R_L = 2.5 \Omega</math></p>
<p>Calculate the coefficients for determining the voltage drop</p> $b = R_L \frac{P_{M\max} - P_{M\min}}{U_{P\max} - U_{P\min}} + U_E$ $c = P_{M\min} \cdot R_L + \frac{P_{M\max} - P_{M\min}}{U_{P\max} - U_{P\min}} \cdot R_L \cdot (U_E - U_{P\min})$	<p>①/③ <math>b = 5.0</math>          ①/④ <math>b = 4.9</math></p> <p>①/③ <math>c = 5.6</math>          ①/④ <math>c = 2.8</math></p>
<p>Calculate the voltage drop based on the coefficients b and c, and compare with <math>\Delta U_{\max}</math></p> $\Delta U = 0.5 \cdot (b - \sqrt{b^2 - 4 \cdot c})$	<p>①/③ <math>\Delta U = 0.5 \cdot [5.0 - \sqrt{5.0^2 - 4 \cdot 5.6}]</math>  <math>\Delta U = 1.7 \text{ V} \times</math> (value too high)</p> <p>①/④ <math>\Delta U = 0.5 \cdot [4.9 - \sqrt{4.9^2 - 4 \cdot 2.8}]</math>  <math>\Delta U = 0.7 \text{ V} \checkmark</math></p>
<p>Determined cable configuration</p>	 <p>8-pin M12 3 m          15-pin TNC 40 m</p>

# Symbols in the cables overviews

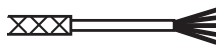
	Connector (male/female)		D-sub connector (male/female)
	Coupling (male/female)		D-sub connector with locking screws (male/female)
	Mounted coupling with flange (male/female)		D-sub connector (male) (interface electronics integrated into the connector)
	Flange socket (male/female)		Mini Delta Ribbon connector (male/female) MUF connector (male/female)
	Angle flange socket (male)		RJ45 connector
	Adapter connector (male/female)		Push-pull connector
	PUR cable		Push-pull flange socket
	PUR cable in protective sleeve		
	Cable with braided shield		
	PUR cable in protective sleeve and steel wire sheathing		

# Adapter cables and connecting cables – EnDat interface (EnDat22)

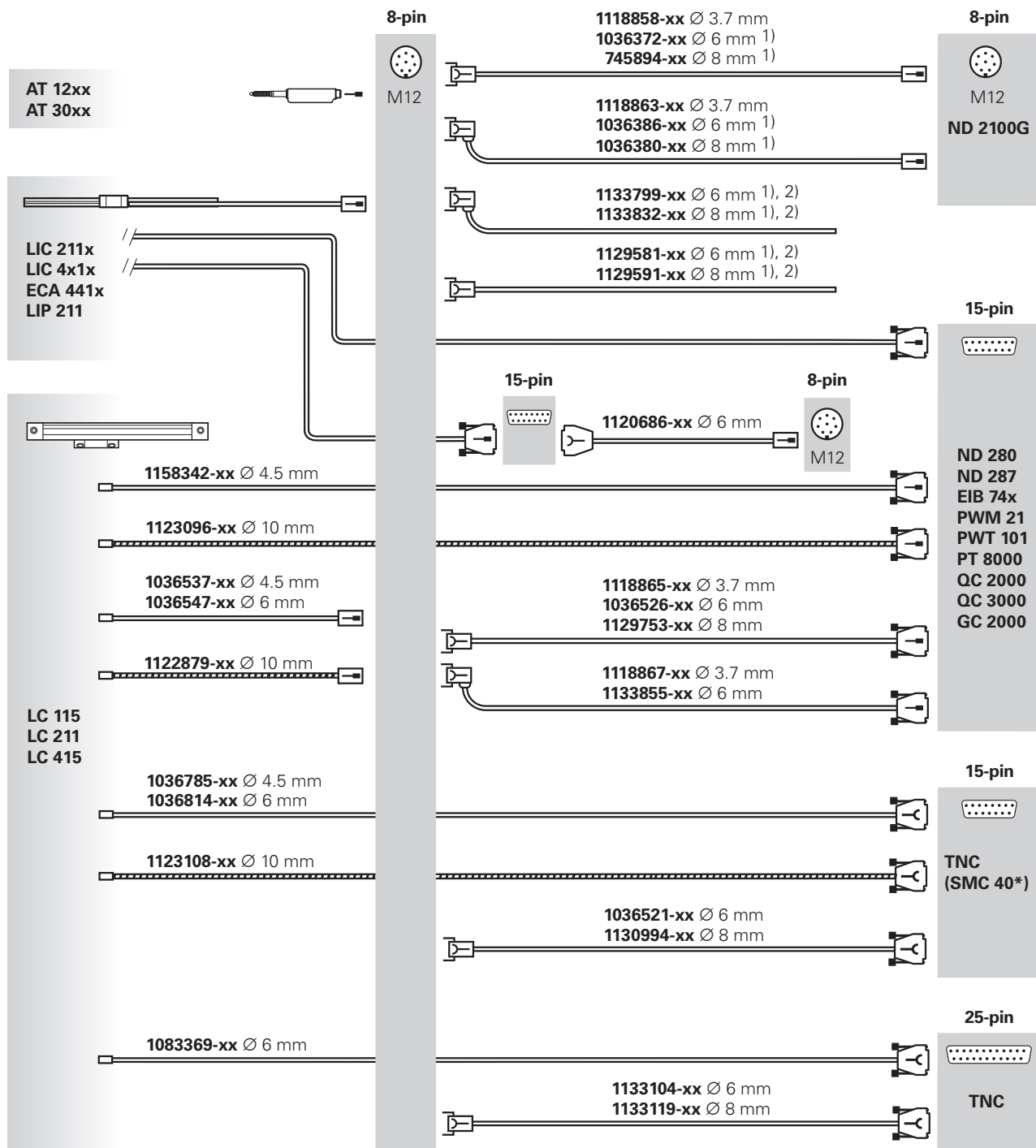

\* Connection to Siemens NC

<sup>1)</sup> Also suitable for Fanuc/Mitsubishi/Panasonic/Yaskawa

<sup>2)</sup> Note connecting element for 8 MHz signal transmission!

# Adapter cables and connecting cables – EnDat interface (EnDat22)

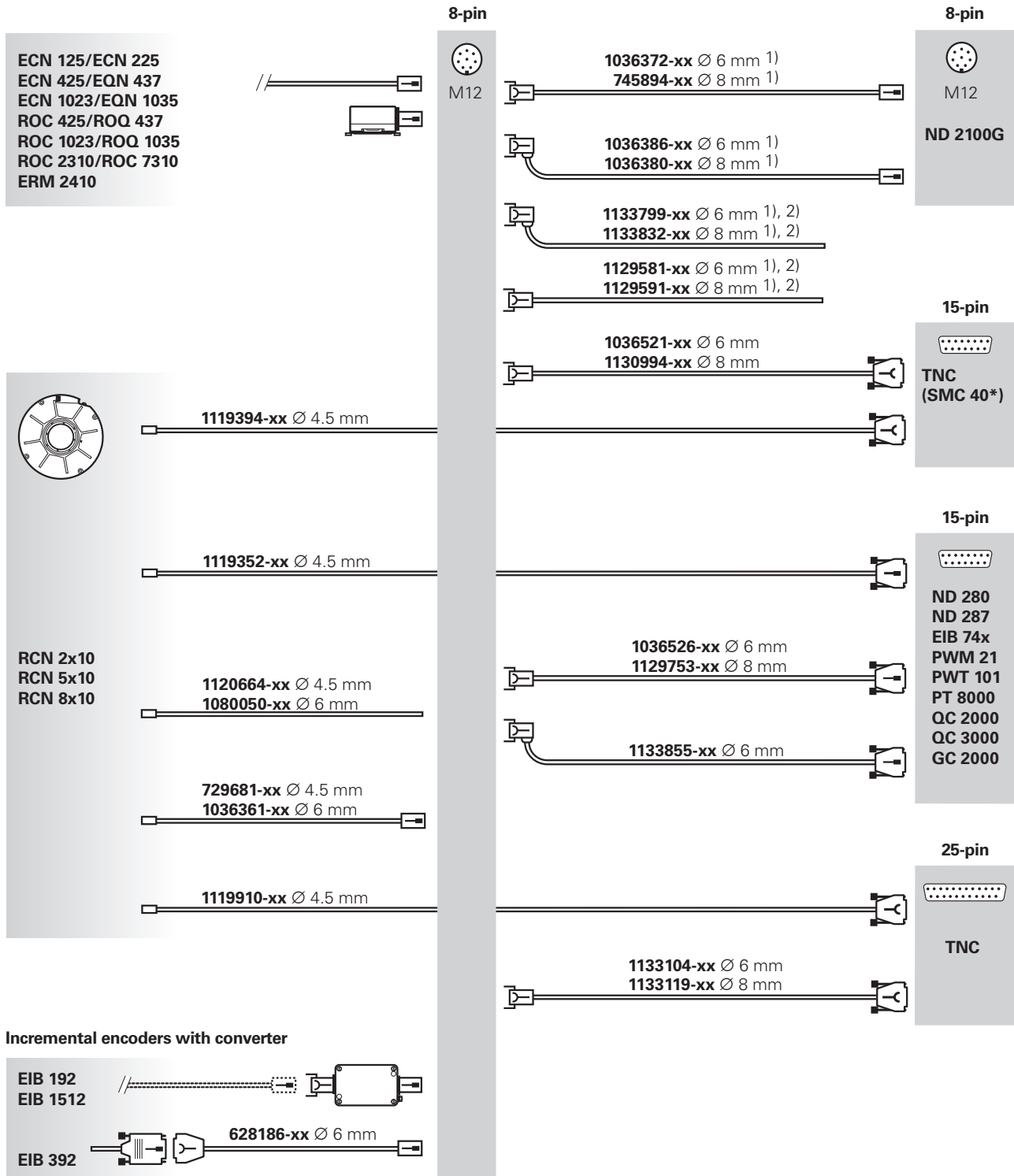



# Adapter cables and connecting cables – DRIVE-CLiQ

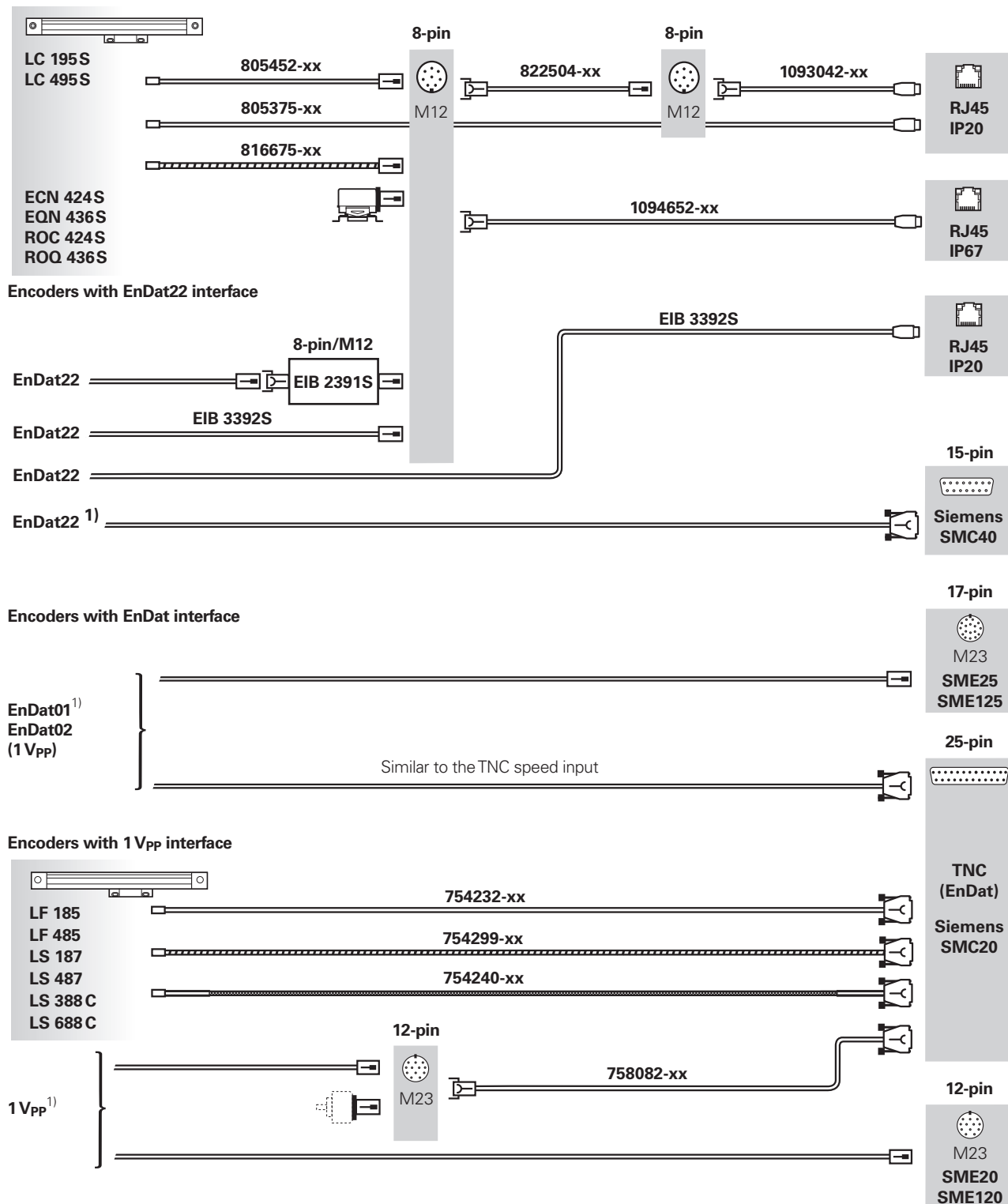

<sup>1)</sup> See associated cable overviews

DRIVE-CLiQ is a registered trademark of Siemens AG.

# Adapter cables and connecting cables – Fanuc Serial Interface

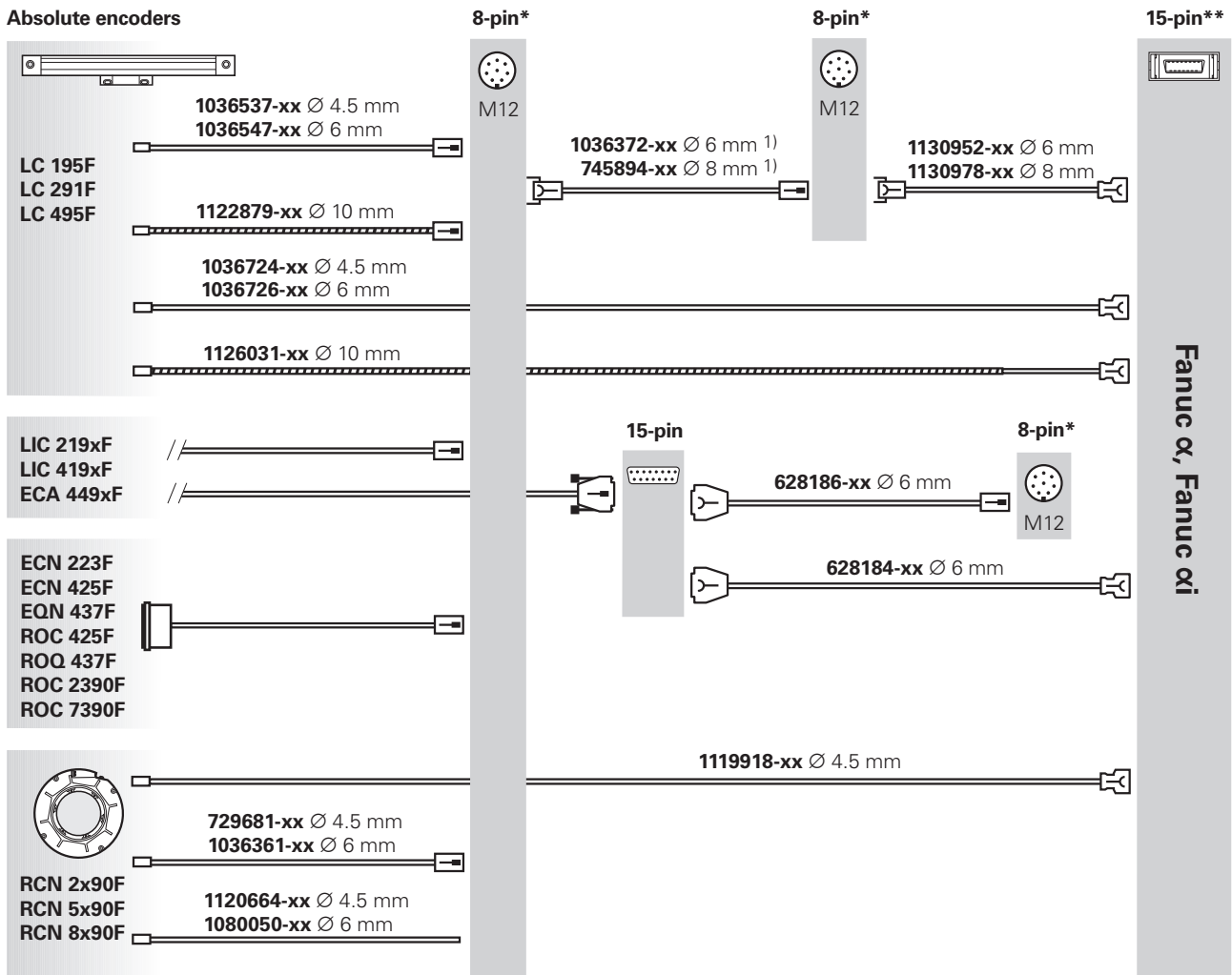

<sup>1)</sup> For more M12 connecting cables, see EnDat interface (EnDat22)  
 \* Recommended for new applications  
 \*\* 20-pin connector housing with 15-pin insert

# Adapter cables and connecting cables – Fanuc Serial Interface

## Absolute encoders

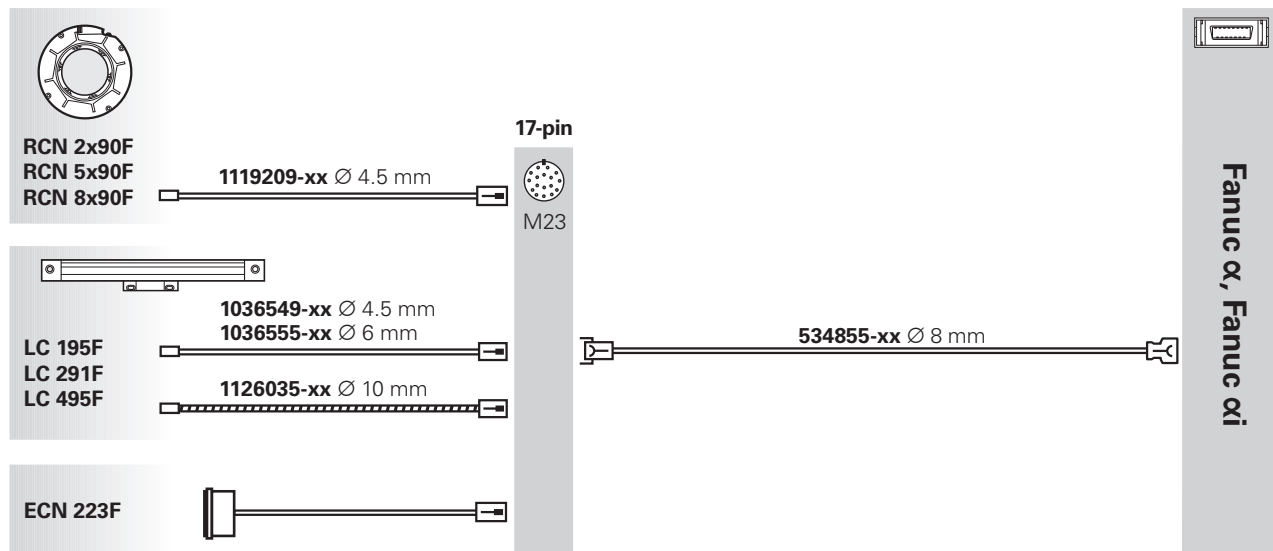

## Incremental encoders with converter

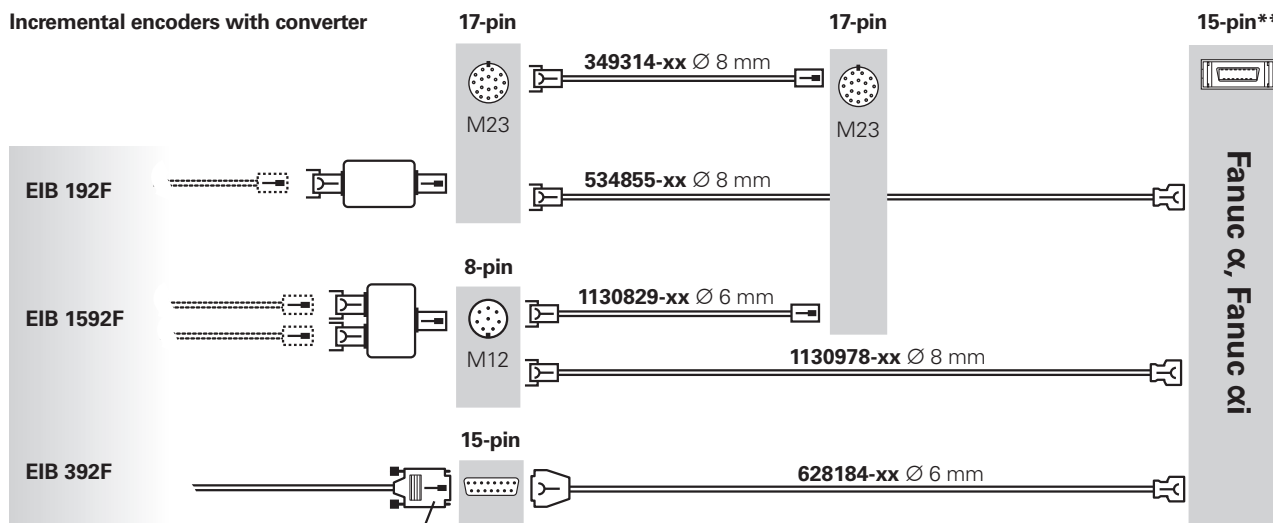

D-sub connector (male), with interface electronics integrated into the connector

## Incremental encoders with TTL

For adapter cables, see the cable overview for TTL signal cables

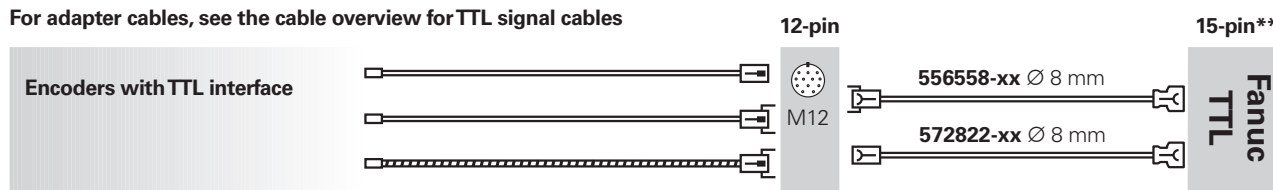

**Caution: Always test the compatibility of the TTL interface between the encoder and Fanuc on an individual basis!**

\*\* 20-pin connector housing with 15-pin insert

# Adapter cables and connecting cables – Mitsubishi high speed interface

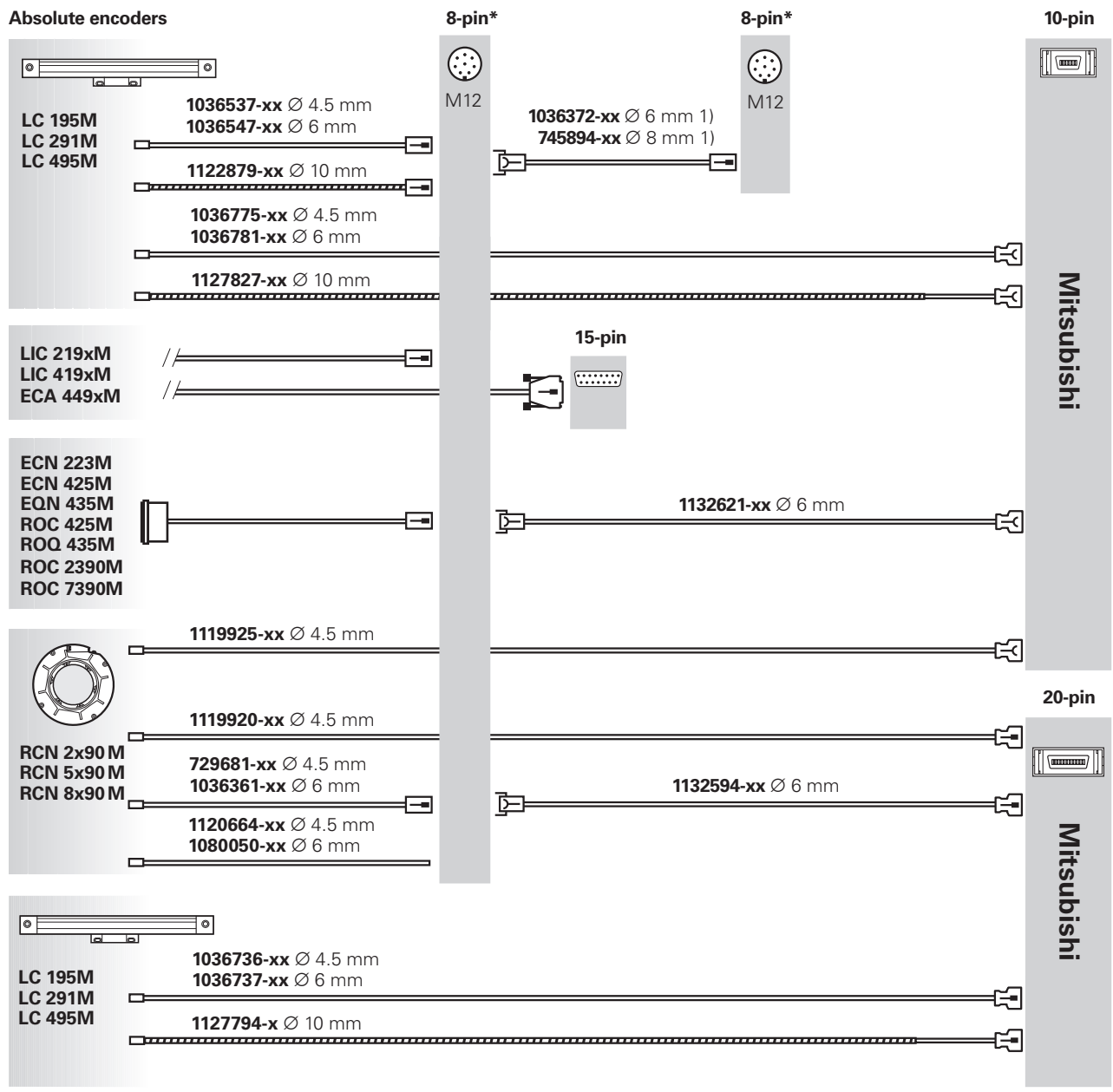

1) For more M12 connecting cables, see EnDat interface (EnDat22)  
 \* Recommended for new applications

# Adapter cables and connecting cables – Mitsubishi high speed interface

## Absolute encoders

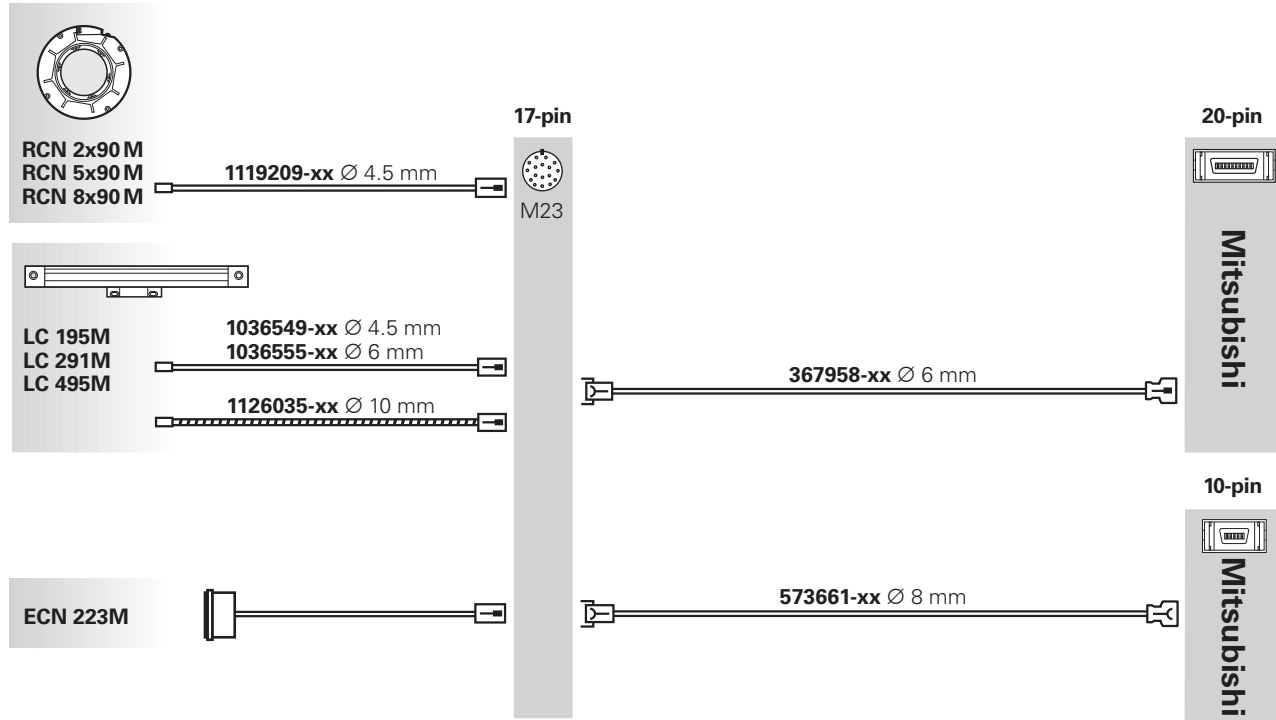

## Incremental encoders with converter

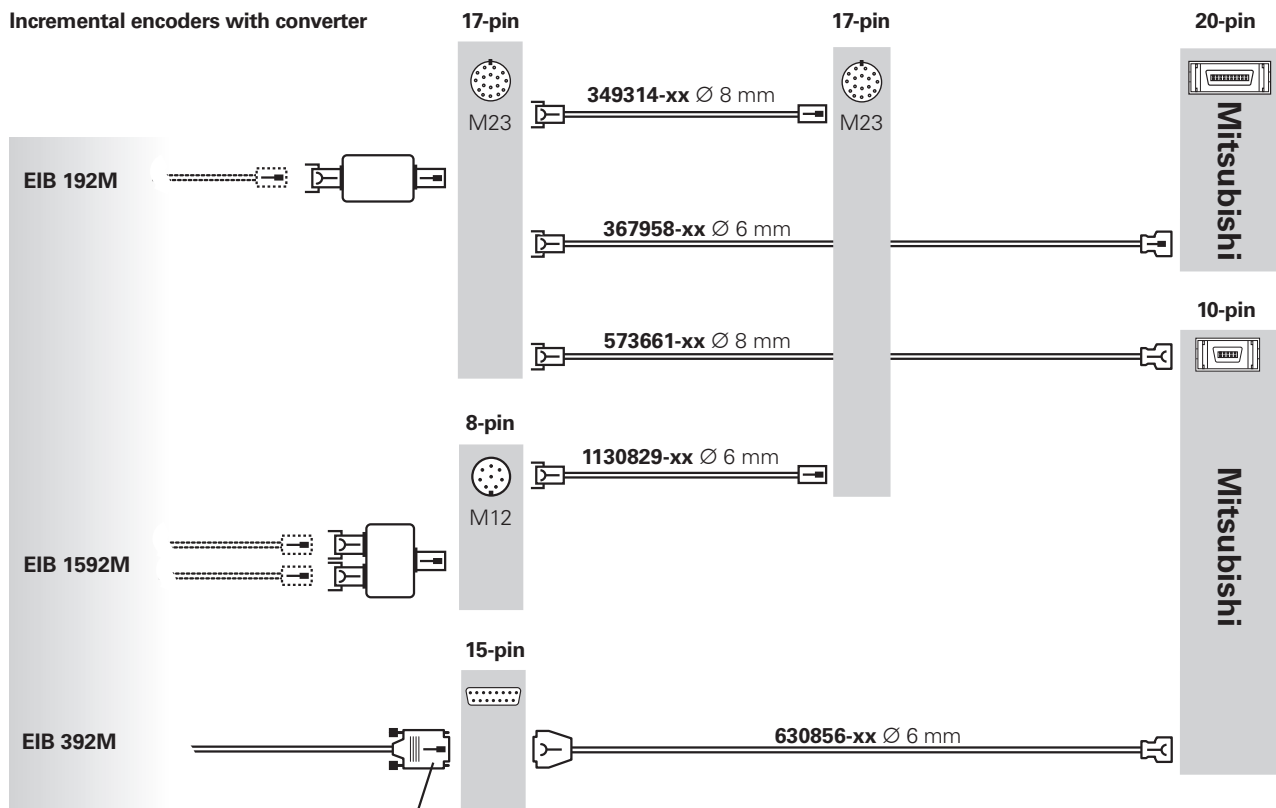

D-sub connector (male), with interface electronics integrated into the connector

# Adapter cables and connecting cables – Panasonic interface

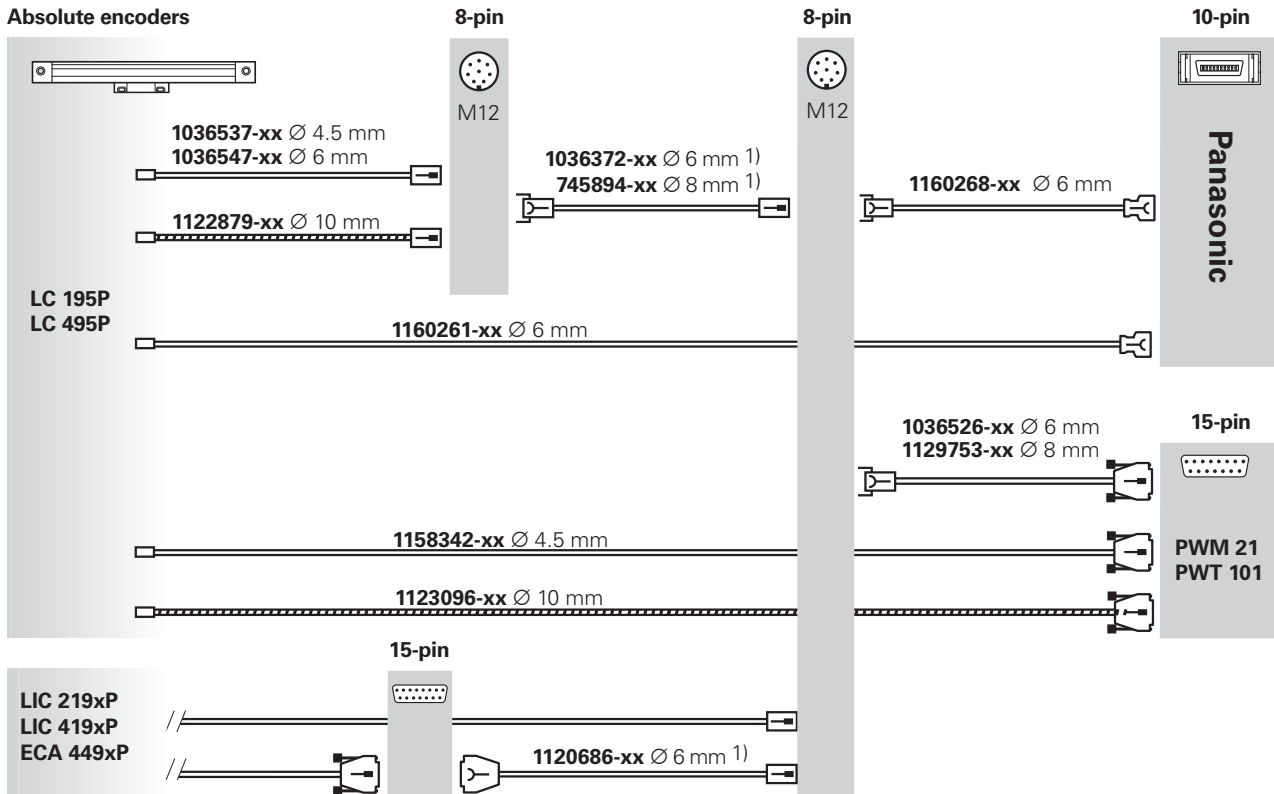

<sup>1)</sup> For more M12 connecting cables, see EnDat interface (EnDat22)

Last changed: 02/2019

# Adapter cables and connecting cables – Yaskawa Serial Interface

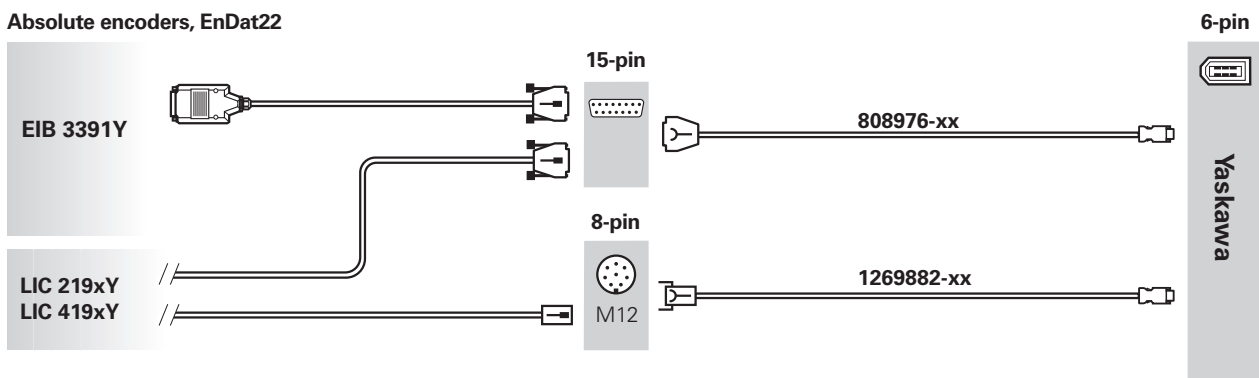

Last changed: 10/2018

# Adapter cables and connecting cables – EnDat interface (EnDat0x) or SSI interface

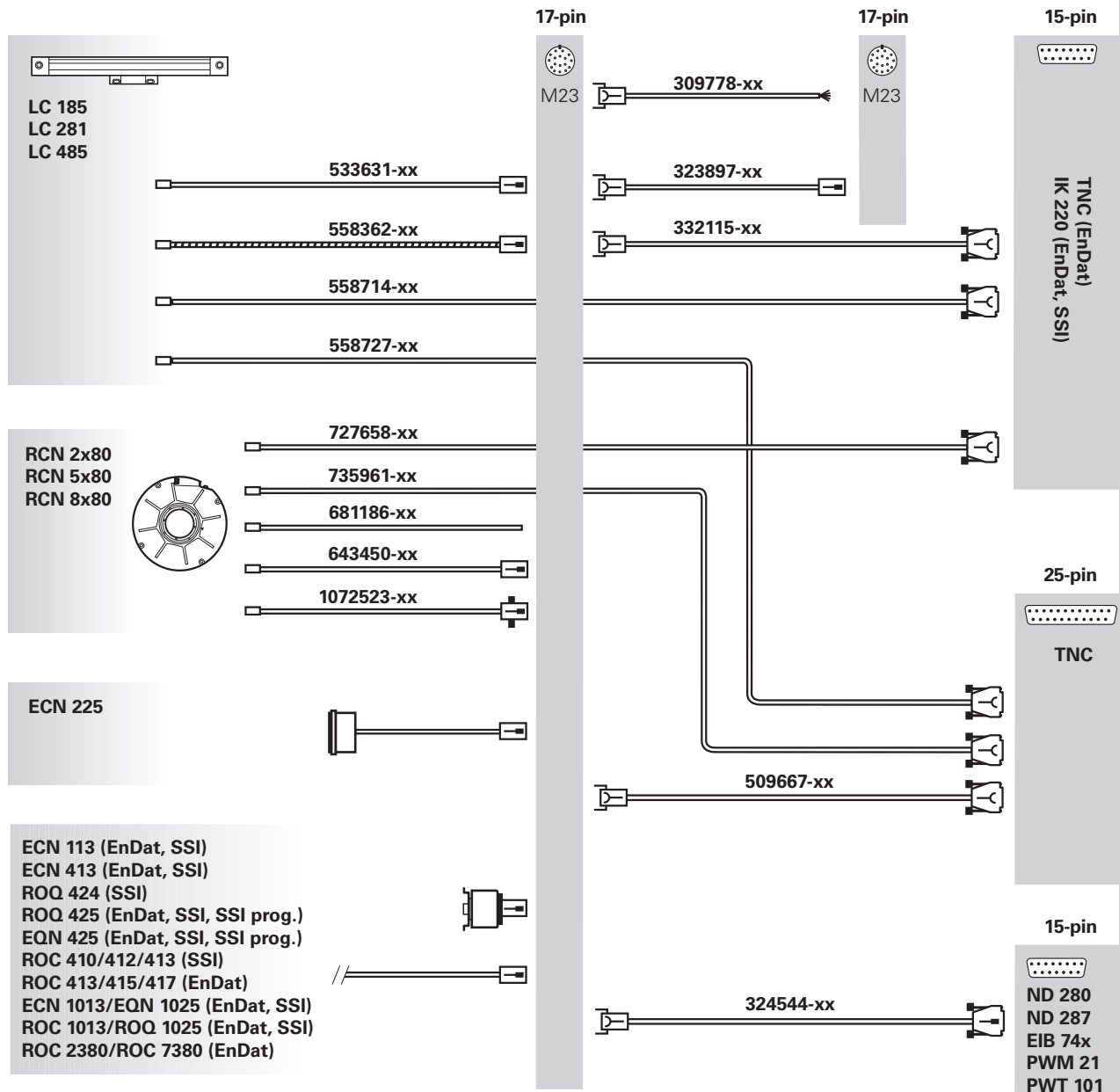

# Adapter cables and connecting cables – 1 V<sub>PP</sub> interface

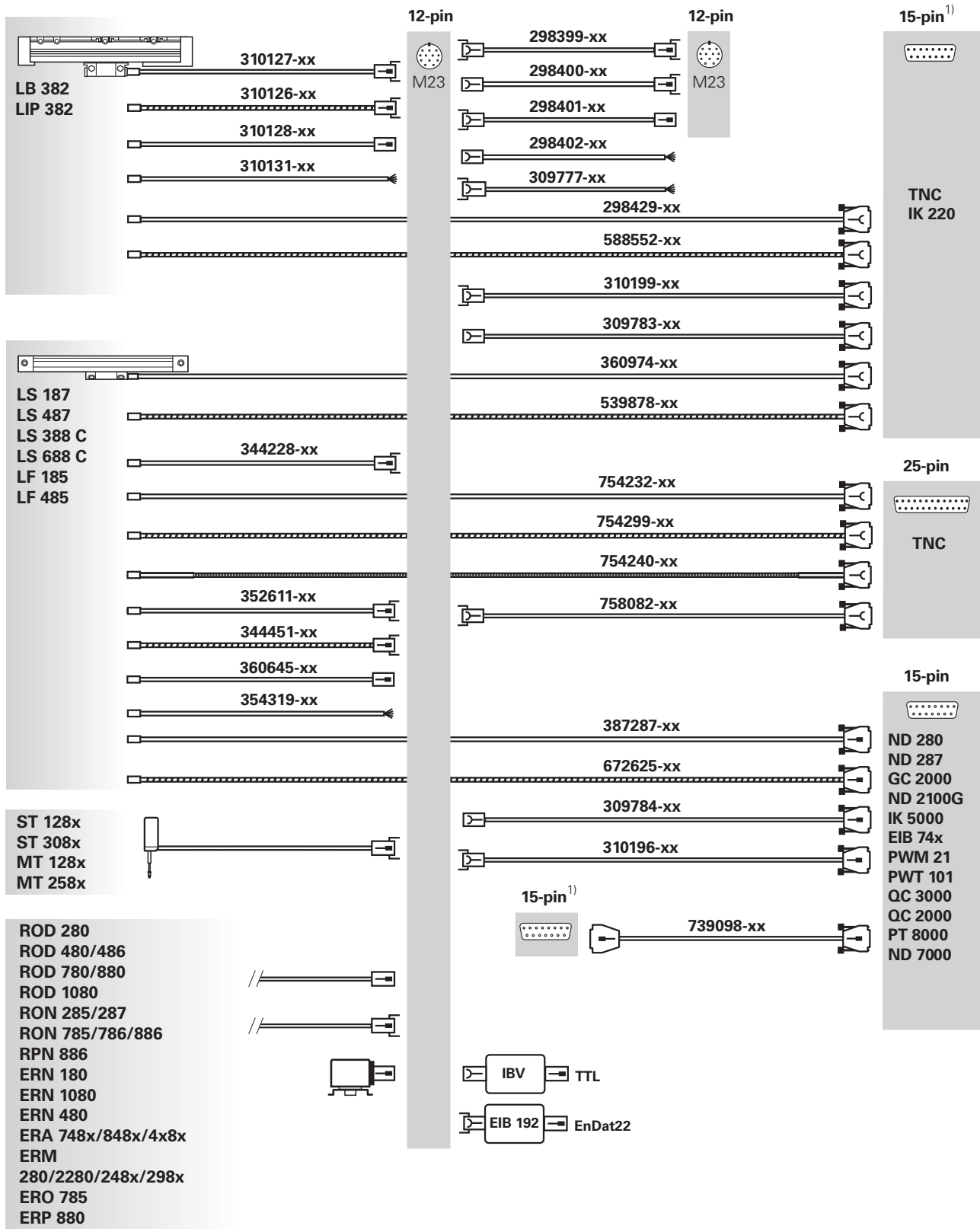

<sup>1)</sup> Identical pin layouts



# Adapter cables and connecting cables – 1 V<sub>PP</sub> interface

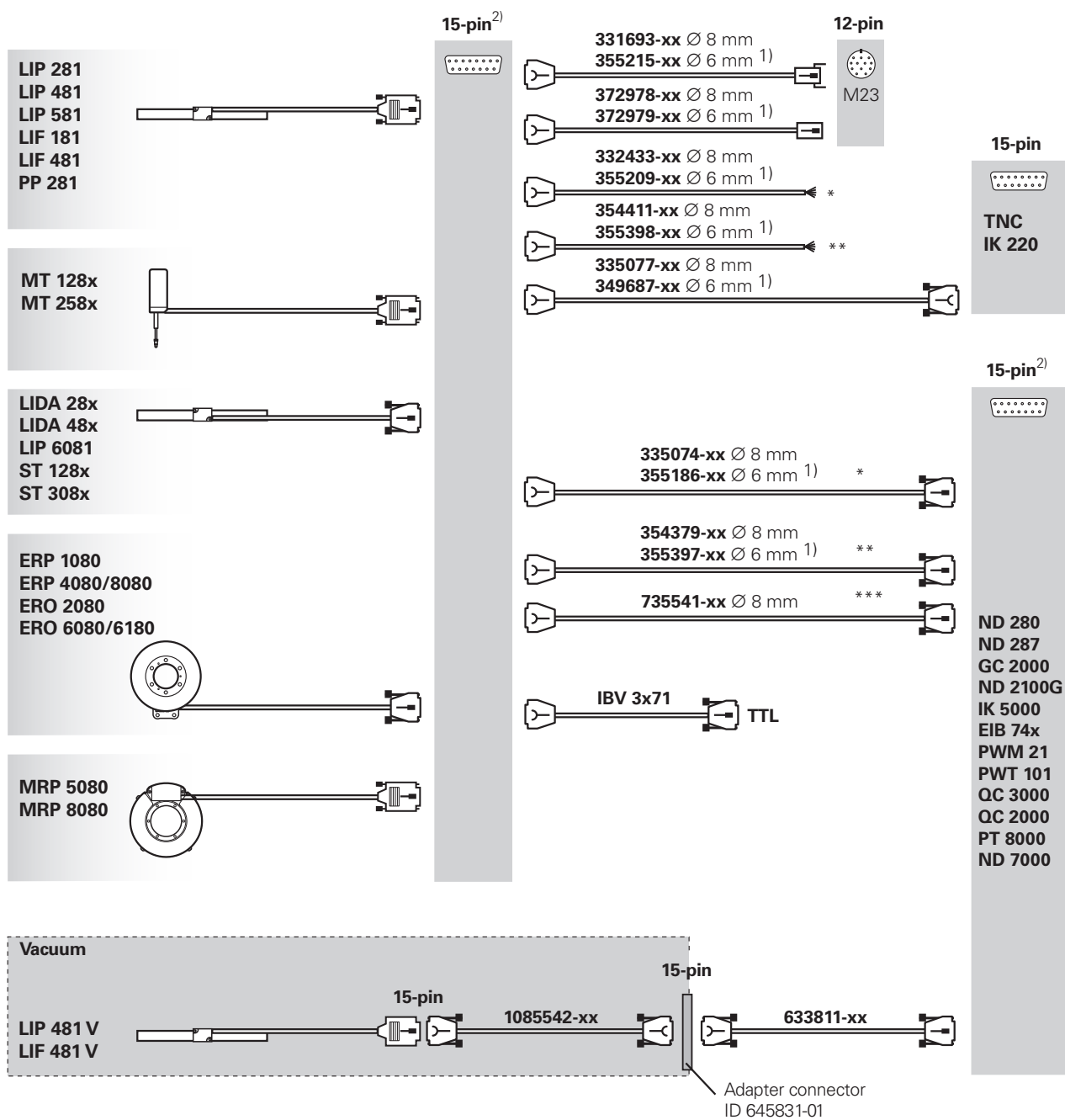

\* Without limit/homing signals

\*\* With limit/homing signals

\*\*\* With programming line for mounting the LIP 281

<sup>1)</sup> Cable length ≤ 9 m

<sup>2)</sup> Pin layouts are identical

# Adapter cables and connecting cables – TTL or HTL interface

## TTL

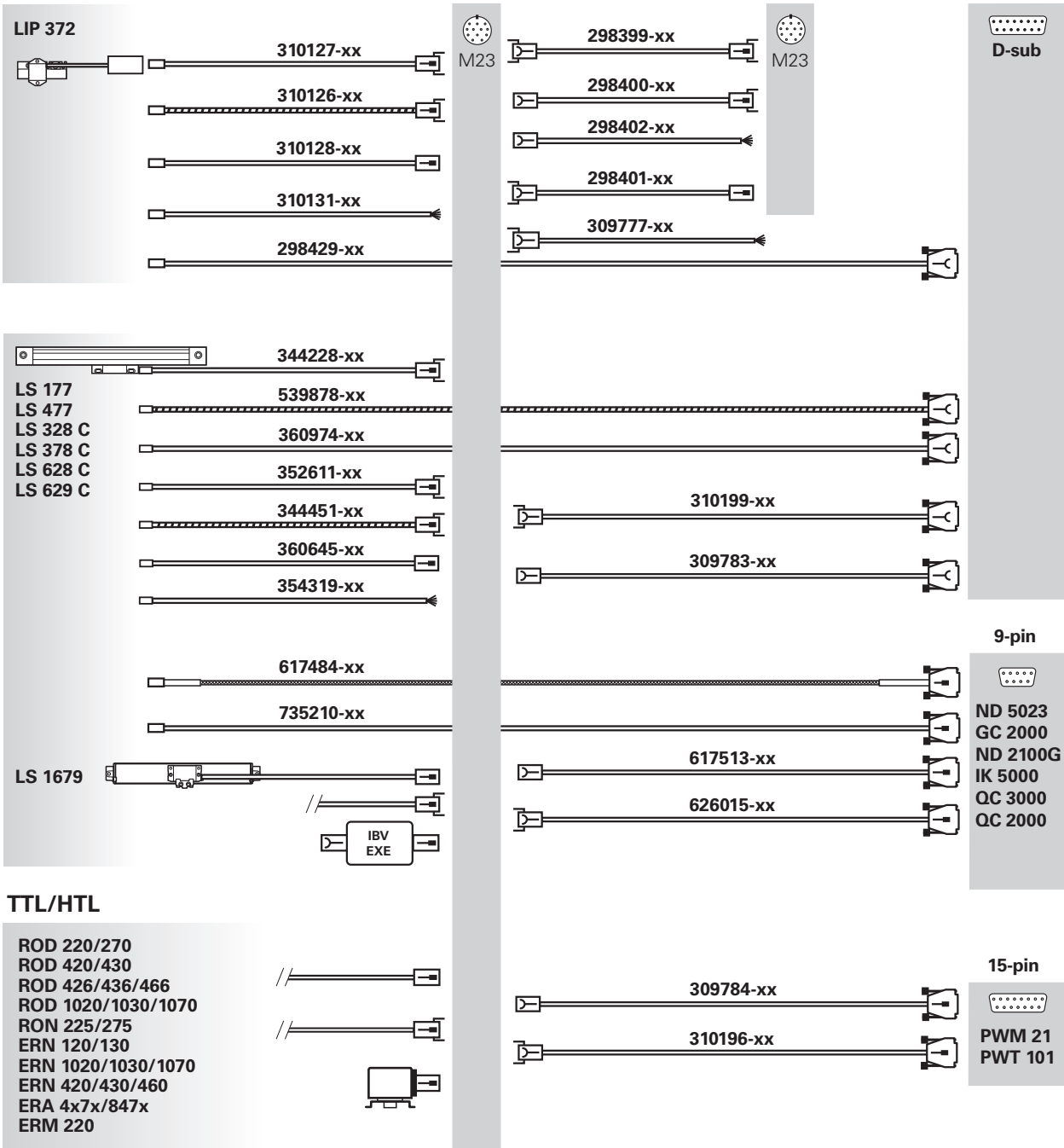

# Adapter cables and connecting cables – TTL or HTL interface

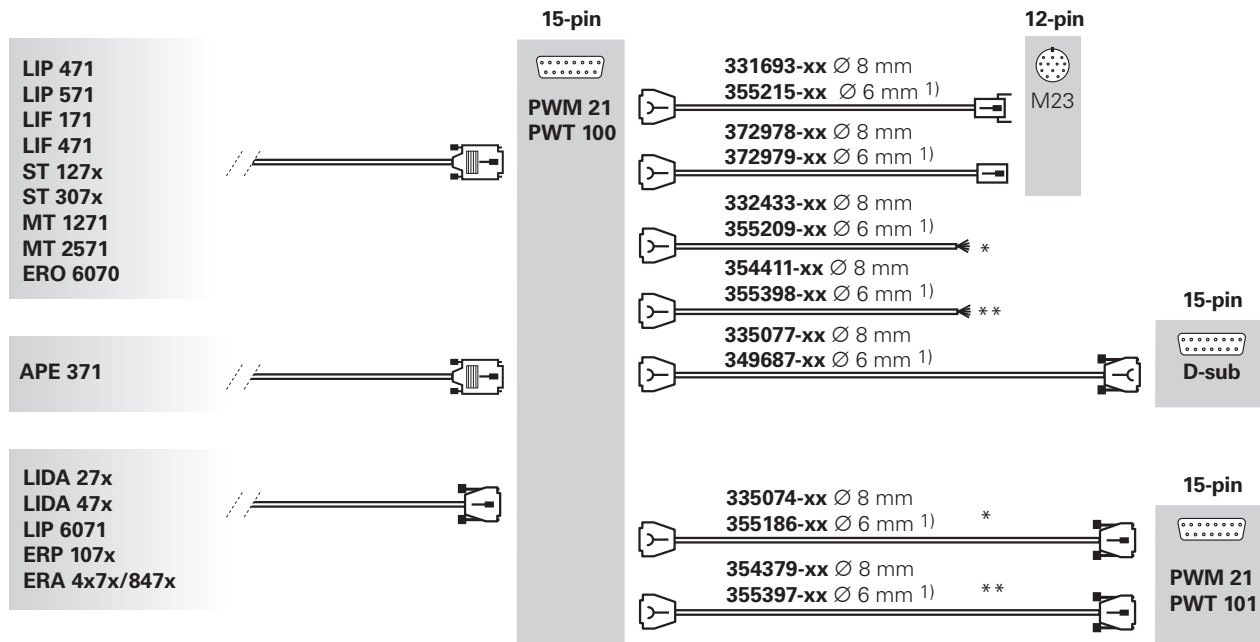

\* Without limit/homing signals  
 \*\* With limit/homing signals  
<sup>1)</sup> Max. cable length ≤ 9 m

# Adapter cables and connecting cables – 11 $\mu$ A<sub>PP</sub> interface

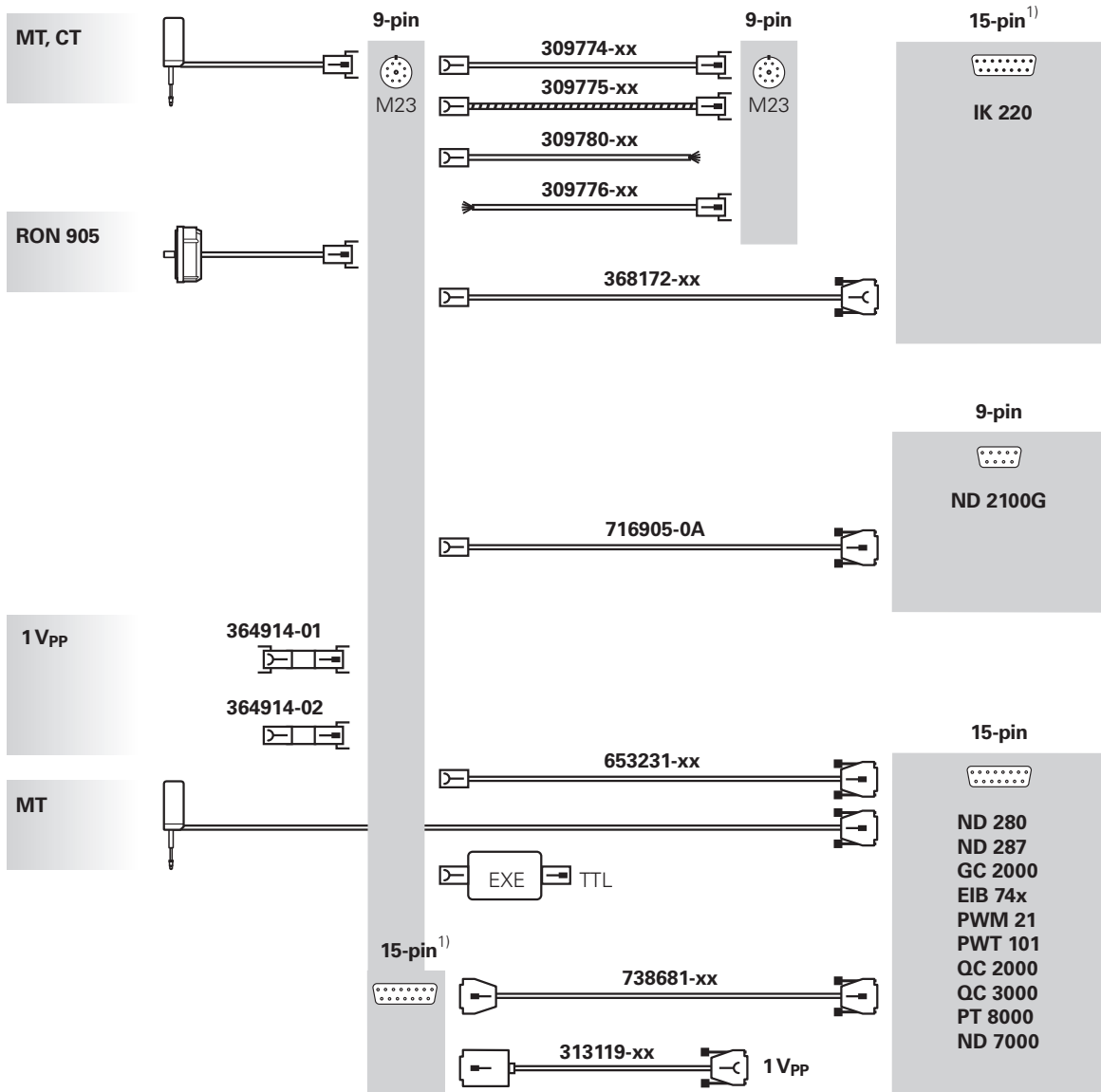

<sup>1)</sup> Pin layouts are identical

# Adapter cables and connecting cables – touch probes with EnDat or HTL interface

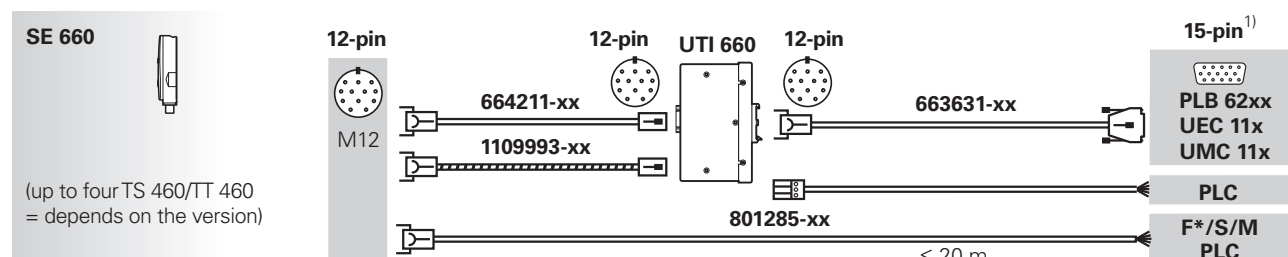
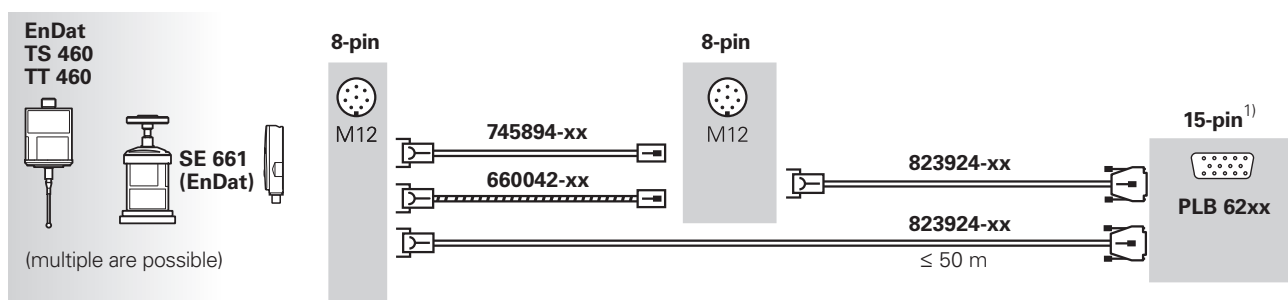
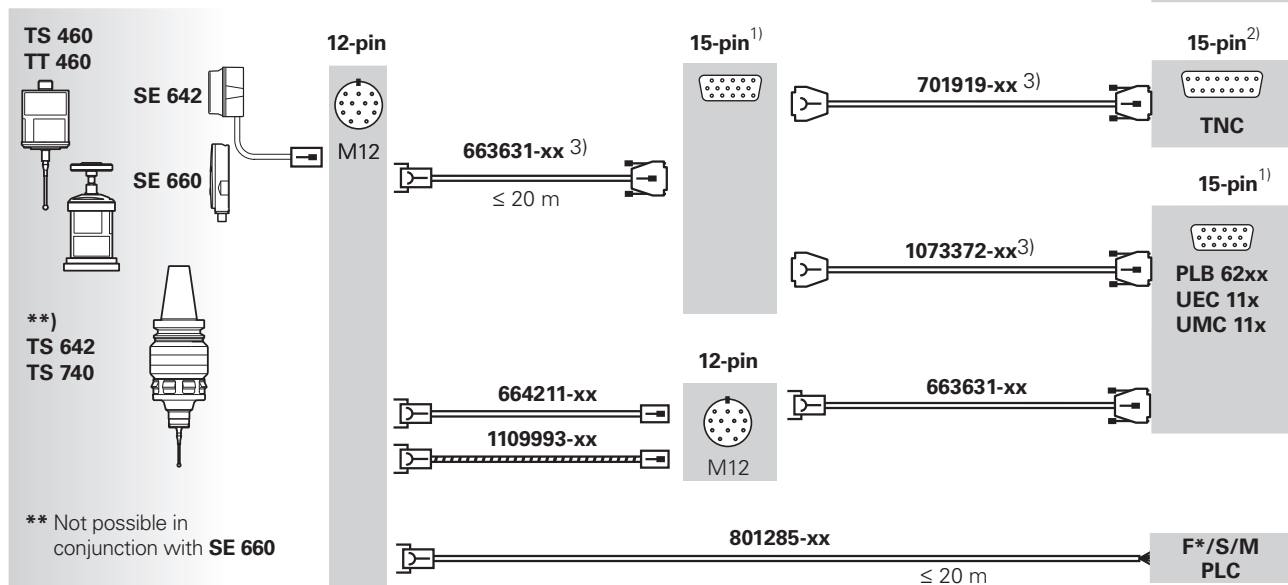
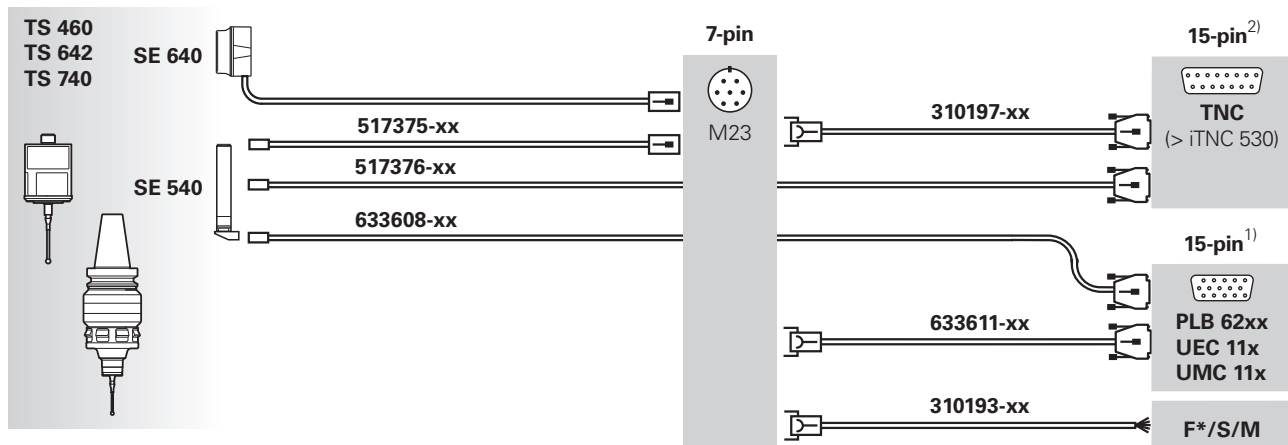

<sup>1), 2)</sup> Pin layouts are identical

<sup>3)</sup> If overall length is over 20 m: ID 663631-xx max. 10 m; the rest with ID 701919-xx/1073372-xx

**F\*/S/M** = Fanuc/Siemens/Mitsubishi/Mazak, **F\*** Fanuc High-Speed Skip via UTI 491

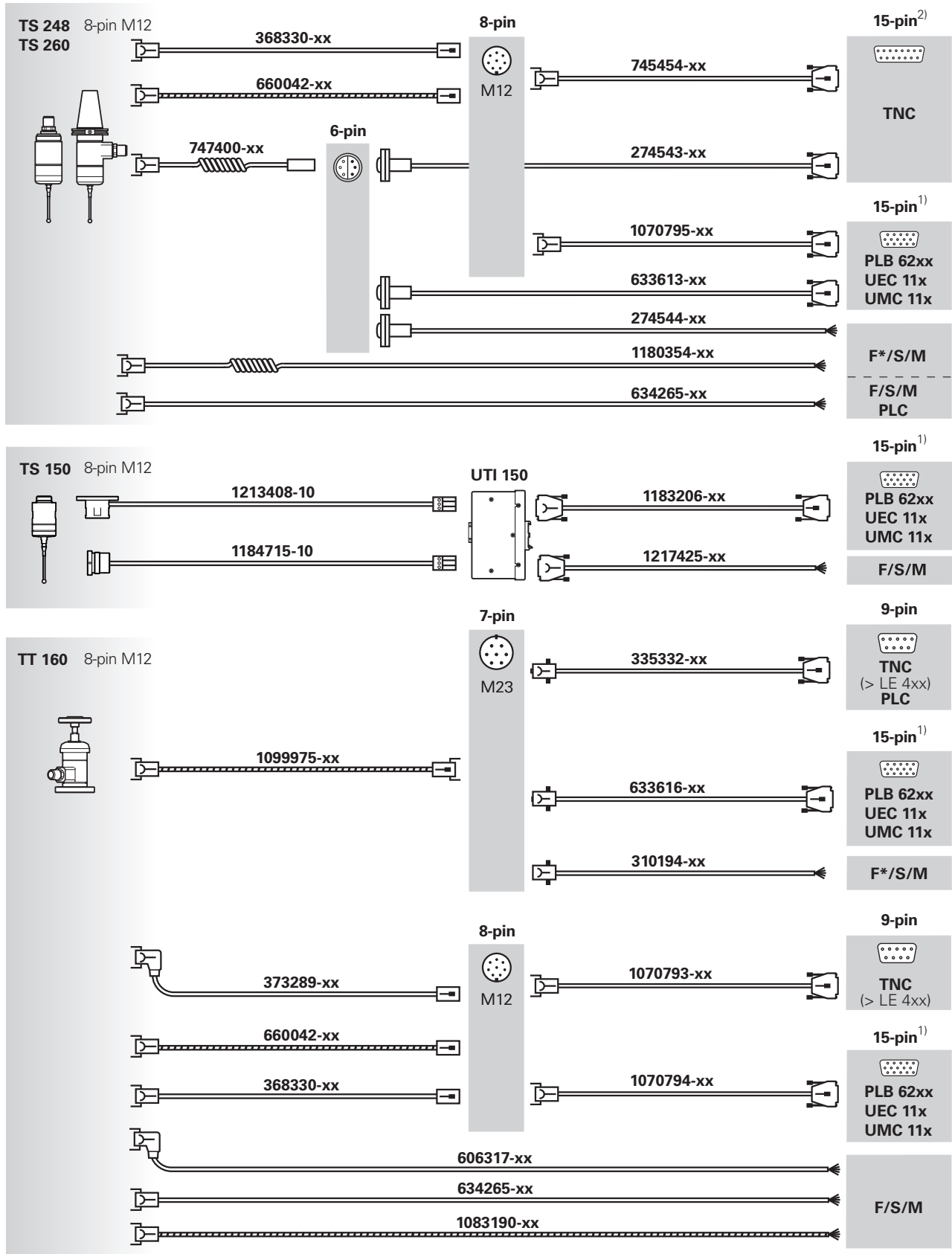

# Adapter cables and connecting cables – touch probes



1), 2) Pin layouts are identical



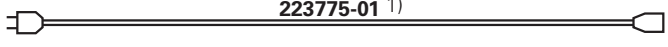
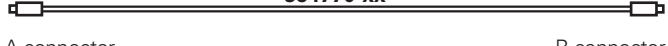
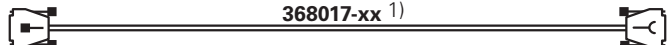

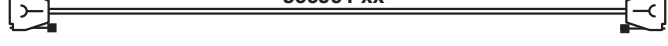
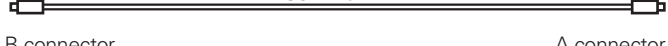

F\*/S/M = Fanuc/Siemens/Mitsubishi/Mazak, F\* Fanuc High-Speed Skip via UTI 491

# Adapter cables and connecting cables – digital readouts

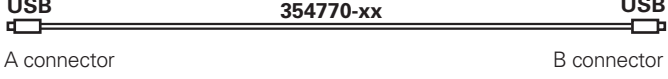
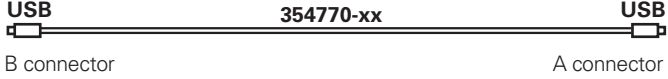
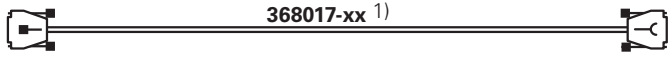
Power cord	 <p>223775-01 <sup>1)</sup></p>	
PC	 <p>USB A connector      354770-xx      B connector</p>	ND 280
V.24 cable to PC	 <p>25-pin      368017-xx <sup>1)</sup></p>	<p>9-pin</p>  <p>ND 280</p>
V.24 cable to PC	 <p>9-pin      366964-xx</p>	
USB to printer	 <p>USB B connector      354770-xx      A connector</p>	PT 8000 ND 7000

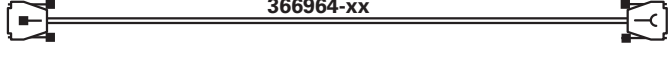
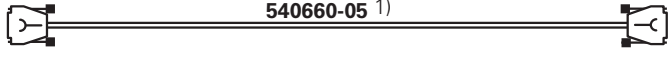
<sup>1)</sup> PVC cable

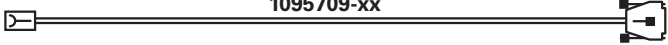
# Adapter cables and connecting cables – evaluation electronics

<b>Power cord</b>	 223775-01 <sup>1)</sup>	<b>Evaluation electronics units</b>
<b>PC</b>	<b>USB</b> A connector  354770-xx B connector	<b>ND 287</b>
<b>USB to printer</b>	<b>USB</b> B connector  354770-xx A connector	<b>GC 2000 ND 2100G QC 2000 QC 3000</b>
<b>V.24 cable to PC</b>	<b>25-pin</b>  368017-xx <sup>1)</sup>	<b>9-pin</b>  <b>ND 287</b>
<b>V.24 cable to PC</b>	<b>9-pin</b>  366964-xx	
<b>V.24 cable to PC</b>	<b>9-pin</b>  540660-05 <sup>1)</sup>	<b>9-pin</b>  <b>ND 2100G</b>
<b>RENISHAW touch probe</b>	<b>5-pin</b>  1095709-xx	<b>15-pin</b>  <b>GC 2000 QC 2000 QC 3000</b>

<sup>1)</sup> PVC cable



# Output cables – EnDat interface (EnDat22)

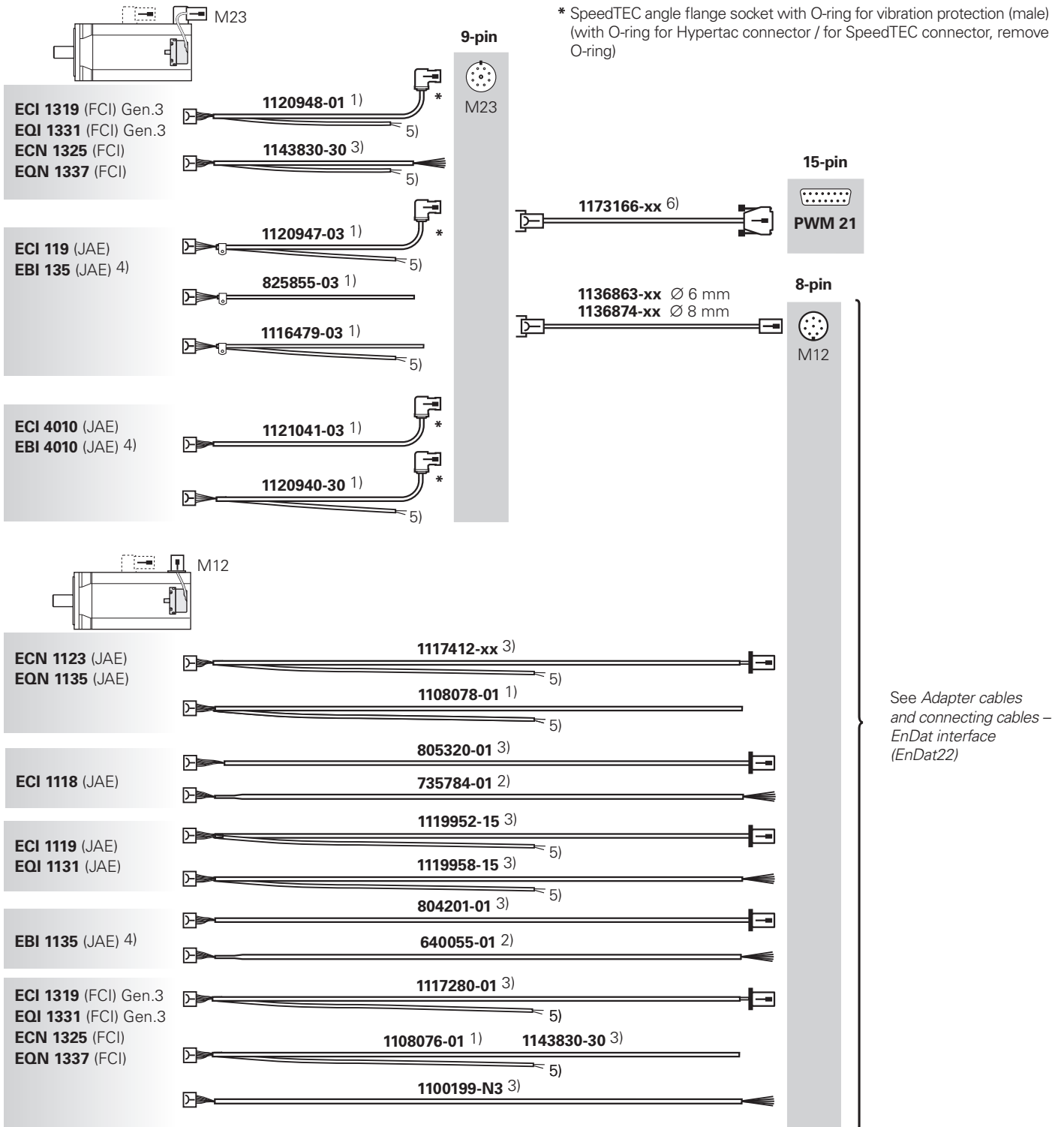

1) EPG cable  
 2) Single wires with heat shrink tubing (without shield)  
 3) TPE single wires with net sleeve (without shield)  
 4) The TNC does not support any buffer battery backup multiturn functions  
 5) Wires for temperature sensors: 2 TPE wires in the heat shrink tubing  
 6) Not for the EBI 135 and EBI 4010

SpeedTEC is a registered trademark of TE Connectivity Industrial GmbH.

# Output cables – EnDat interface (EnDat22)

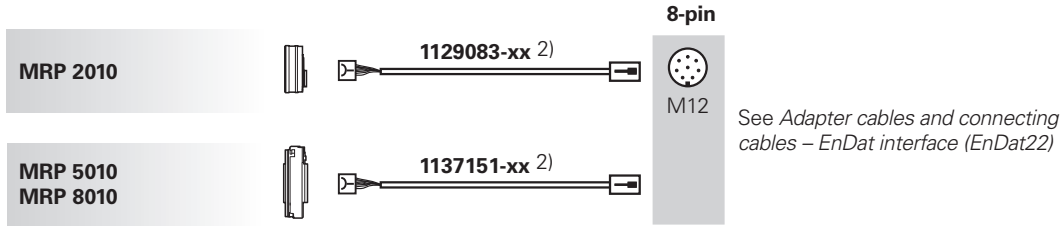

## HMC 6 output cables and power cables with encoder communication

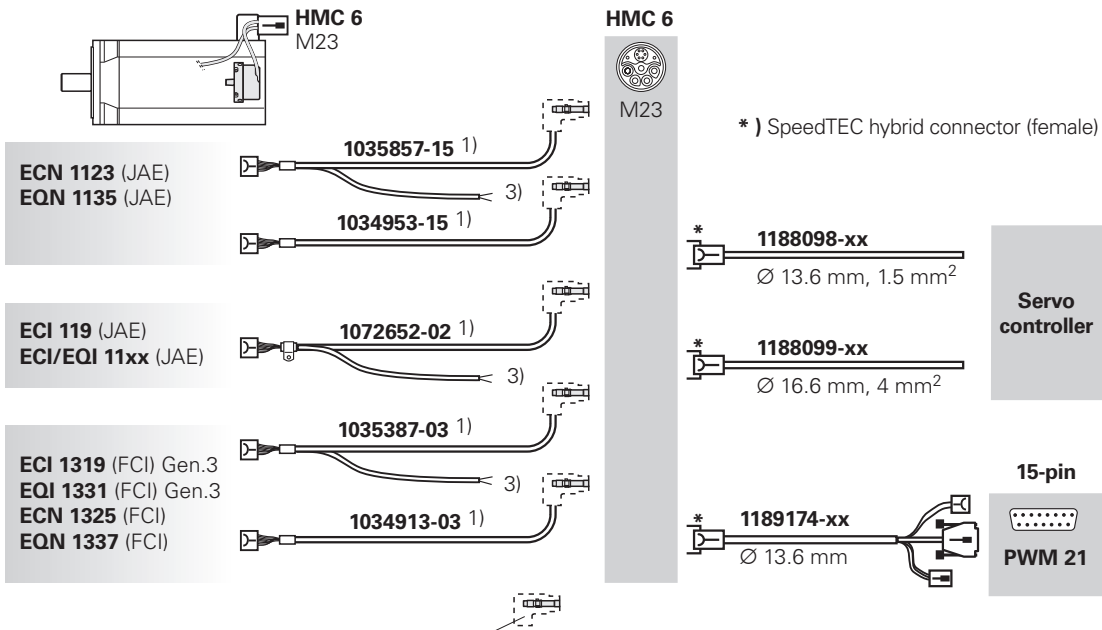

SpeedTEC hybrid flange socket is not included in delivery.  
For more information, see the *Connecting elements* chapter and the *HMC 6 Product Information* document.

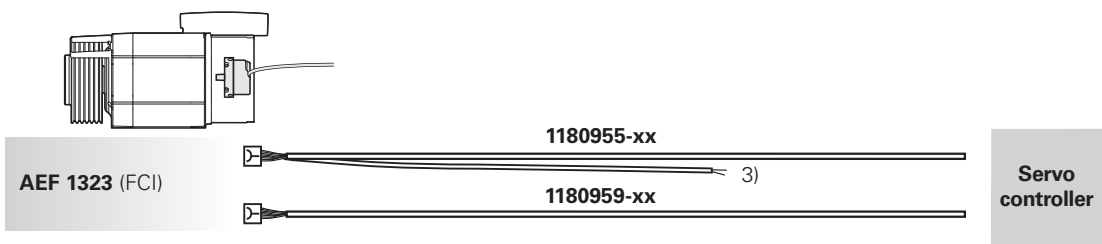

## Testing cables to PWM 21

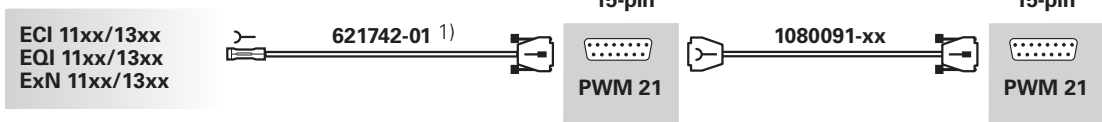

- 1) EPG cable
- 2) Cable clamp included
- 3) Wires for temperature sensors: 2 TPE wires in heat shrink tubing

== PUR cable

SpeedTEC is a registered trademark of TE Connectivity Industrial GmbH.

# Output cables – DRIVE-CLiQ

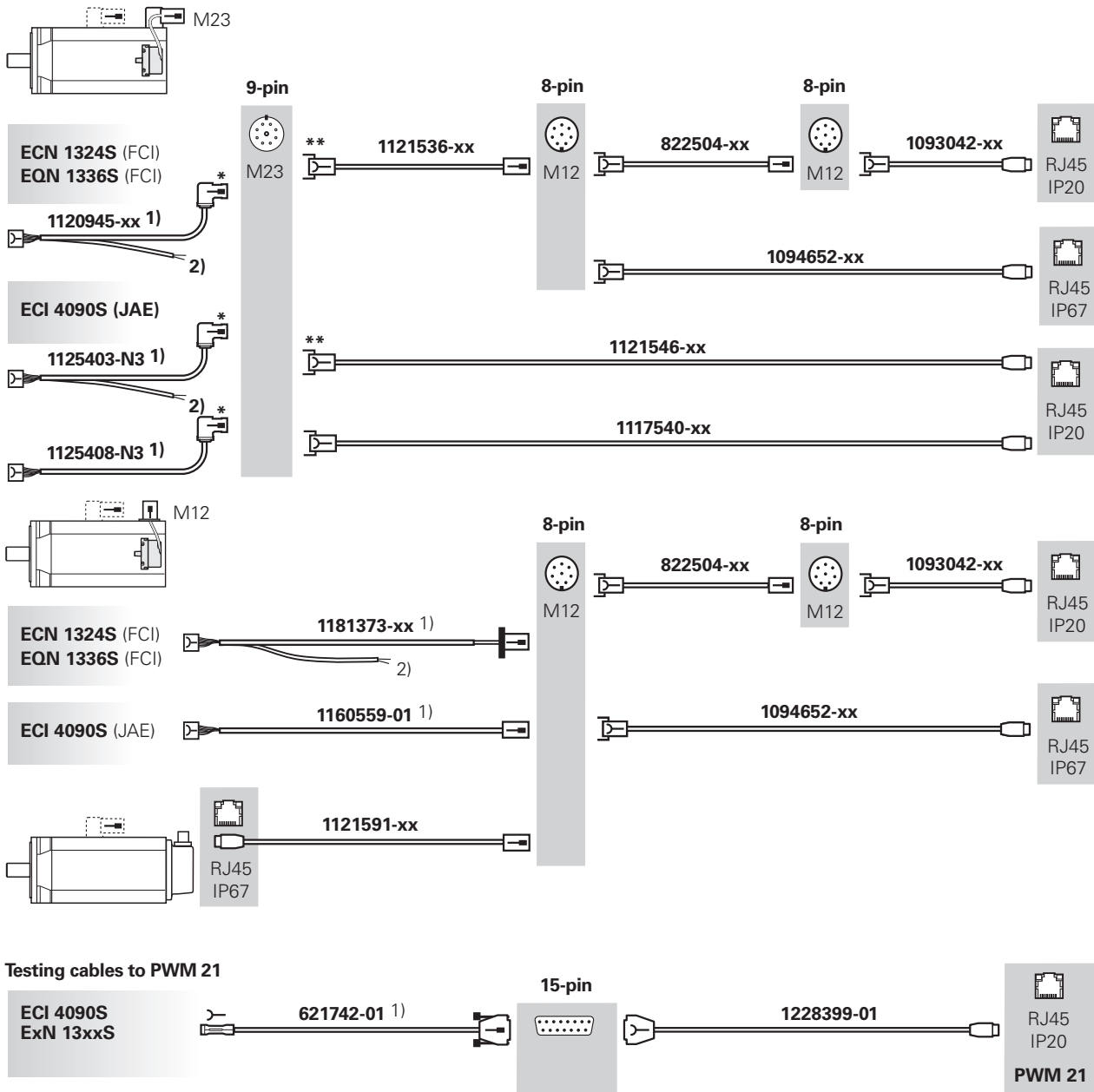

\* SpeedTEC angle flange socket with O-ring for vibration protection (male) (with O-ring for Hypertac connector / for SpeedTEC connector, remove O-ring)

\*\* SpeedTEC connector (female)

1) EPG cable

2) Wires for temperature sensor: 2 TPE wires in the heat shrink tubing

DRIVE-CLiQ is a registered trademark of Siemens AG.

SpeedTEC is a registered trademark of TE Connectivity Industrial GmbH.

# Output cables – EnDat interface (EnDat01)

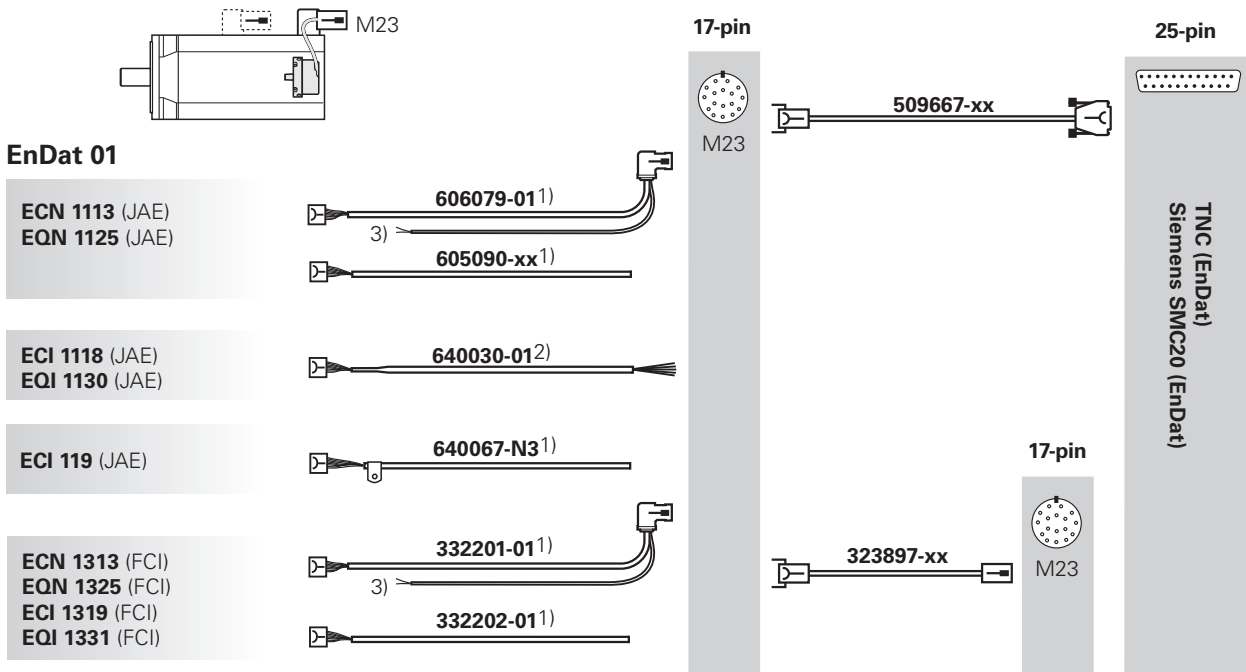

Motors from HEIDENHAIN for connection to TNCs have a different connector layout and must not be connected with the cables listed here. For suitable cables, refer to the *Cable overview* in the TNC brochure *Information for the Machine Tool Builder*.

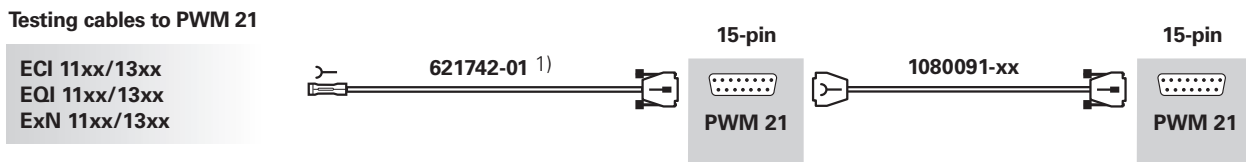

- 1) EPG cable
- 2) Single wires with heat shrink tubing (without shield)
- 3) Wires for temperature sensors: 2 polyolefin wires in the heat shrink tubing

# Output cables – 1 V<sub>PP</sub> or TTL interface

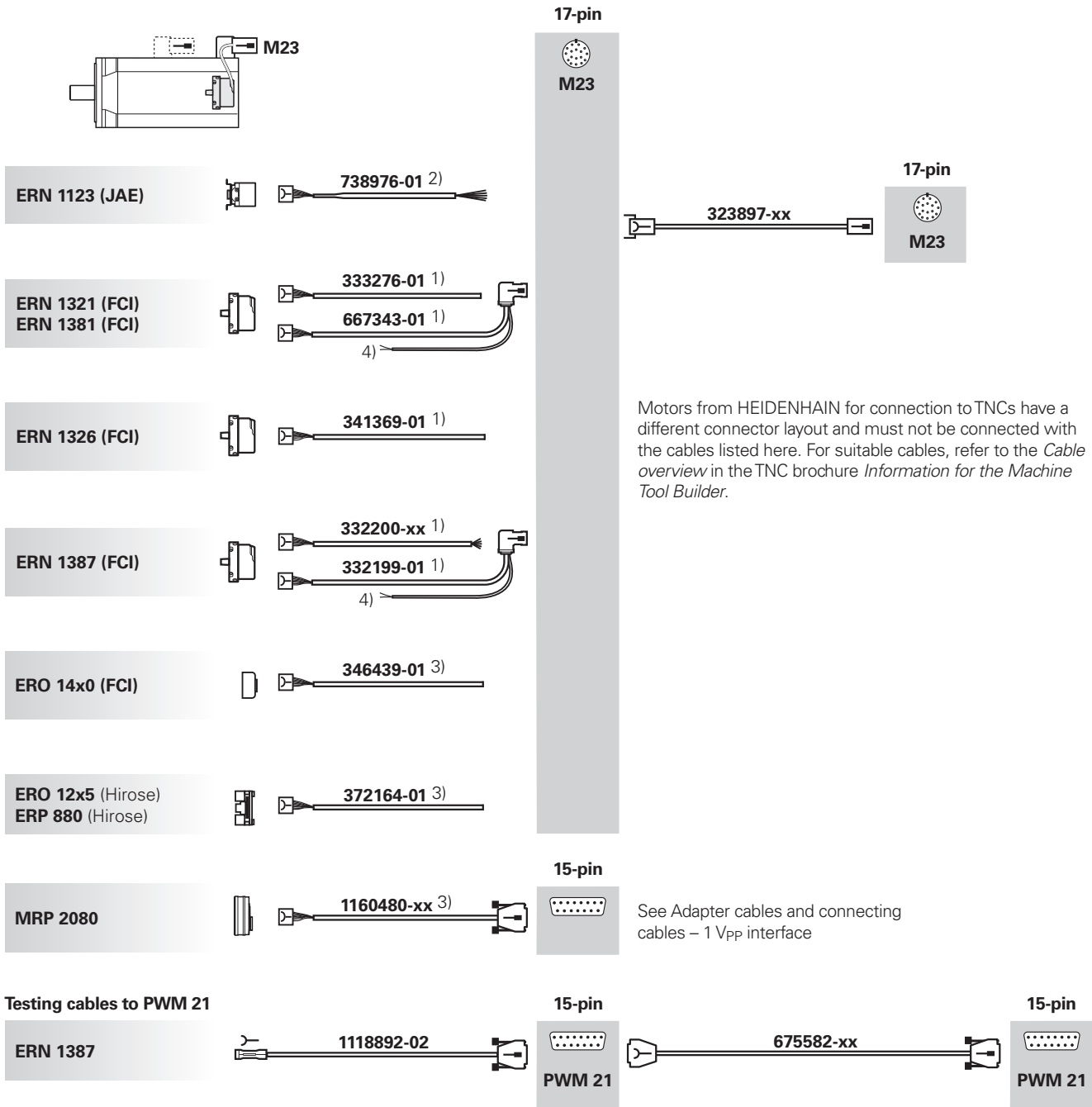

- <sup>1)</sup> EPG cable
- <sup>2)</sup> Single wires with heat shrink tubing (without shield)
- <sup>3)</sup> Cable clamp included
- <sup>4)</sup> Wires for temperature sensors: 2 polyolefin wires in the heat shrink tubing

# Cable list

## Information about the cable list

The cable list contains all of the available HEIDENHAIN cables. The cables are sorted by ID number in ascending order. The most important selection criteria are listed for each cable.

### Cable diameter

An important criterion for the minimum bending radius of the cable, besides the material of the cable jacket, is the cable diameter (see *General information*).

### Length

HEIDENHAIN cables are available in various predefined lengths. Special lengths are available upon request. For information on permissible cable lengths, please refer to the *Cable lengths* chapter and the *Interfaces of HEIDENHAIN Encoders* brochure.

### A<sub>P</sub>

The cross section of the supply lines (A<sub>P</sub>) is used to determine the voltage drop in the lines (see the *Interfaces of HEIDENHAIN Encoders* brochure).

For cables with the prefix "2 x" in front of the information about the cable cross section (e.g., 2 x 0.14 mm<sup>2</sup>), two wires are available for U<sub>P</sub> and GND, respectively.

These cables can be used for remote sense control. The two wires should be used in parallel.

### Use with

The "Use with" column lists typical interfaces and applications for the HEIDENHAIN pre-assembled cables. These potential applications are merely examples. Further applications are possible after consultation with HEIDENHAIN.

Where relevant, the interfaces are indicated by their names or order designations (possibly in abbreviated form). For more information, please refer to the *Interfaces of HEIDENHAIN Encoders* brochure.













Some product groups are indicated with their product group designations:











TS/TT: Touch probes  
 ND: Evaluation electronics and digital readouts  
 QUADRA-CHEK: Evaluation electronics

ID		Length	A <sub>P</sub>	Use with
1130994-xx	<b>APK</b> ∅ 8 mm; 8-pin M12 connector (female) and 15-pin D-sub connector (female) 	1 m to 50 m	2 x 0.35 mm <sup>2</sup>	EnDat22

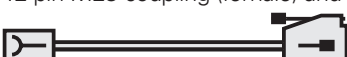



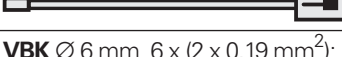
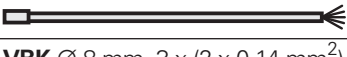





Example from the cable list





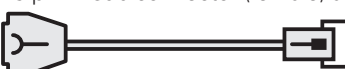





# Cable list – sorted by ID number





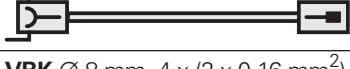
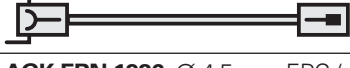

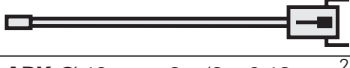





ID		Length	A <sub>P</sub>	Use with
223775-01	<b>Power cable</b> PVC, 3 x 1.0 mm <sup>2</sup> for digital readouts/evaluation electronics 	3 m	1.0 mm <sup>2</sup>	ND
274543-xx	<b>APK</b> , PUR, Ø 8 mm, 4 x (2 x 0.16 mm <sup>2</sup> ) + 4 x 0.5 mm <sup>2</sup> ; 6-pin push-pull flange socket and 15-pin D-sub connector (male) 	1 m to 20 m	0.5 mm <sup>2</sup>	TS/TT
274544-xx	<b>VBK</b> , PUR, Ø 8 mm, 4 x (2 x 0.16 mm <sup>2</sup> ) + 4 x 0.5 mm <sup>2</sup> ; 6-pin push-pull flange socket 	1 m to 20 m	0.5 mm <sup>2</sup>	TS/TT
289440-xx	<b>APK</b> , PUR, Ø 8 mm, 4 x (2 x 0.16 mm <sup>2</sup> ) + 4 x 0.5 mm <sup>2</sup> + 4 x 0.16 mm <sup>2</sup> ; 17-pin M23 connector (female) and 25-pin D-sub connector (female) 	1 m to 30 m	2 x 0.5 mm <sup>2</sup>	1 V <sub>PP</sub> + Z1
298399-xx	<b>VBK</b> , PUR, Ø 8 mm, 4 x (2 x 0.16 mm <sup>2</sup> ) + 4 x 0.5 mm <sup>2</sup> ; 12-pin M23 connector (female) and 12-pin M23 connector (male) 	1 m to 50 m	2 x 0.5 mm <sup>2</sup>	1 V <sub>PP</sub> TTL HTL
298400-xx	<b>VBK</b> , PUR, Ø 8 mm, 4 x (2 x 0.16 mm <sup>2</sup> ) + 4 x 0.5 mm <sup>2</sup> ; 12-pin M23 coupling (female) and 12-pin M23 connector (male) 	1 m to 50 m	2 x 0.5 mm <sup>2</sup>	1 V <sub>PP</sub> TTL HTL
298401-xx	<b>VBK</b> , PUR, Ø 8 mm, 4 x (2 x 0.16 mm <sup>2</sup> ) + 4 x 0.5 mm <sup>2</sup> ; 12-pin M23 connector (female) and 12-pin M23 coupling (male) 	1 m to 50 m	2 x 0.5 mm <sup>2</sup>	1 V <sub>PP</sub> TTL HTL
298402-xx	<b>VBK</b> , PUR, Ø 8 mm, 4 x (2 x 0.16 mm <sup>2</sup> ) + 4 x 0.5 mm <sup>2</sup> ; 12-pin M23 coupling (female) and stripped cable end 	1 m to 50 m	2 x 0.5 mm <sup>2</sup>	1 V <sub>PP</sub> TTL HTL
298429-xx	<b>APK</b> , PUR, Ø 6 mm, 6 x (2 x 0.19 mm <sup>2</sup> ); 12-pin LS connector (large) and 15-pin D-sub connector (female) 	1 m to 9 m	2 x 0.19 mm <sup>2</sup>	1 V <sub>PP</sub> TTL
309773-xx	<b>VBK</b> , PUR, Ø 8 mm, 3 x (2 x 0.16 mm <sup>2</sup> ) + 2 x 1.0 mm <sup>2</sup> ; 9-pin M23 connector (female) and 9-pin M23 connector (male) 	1 m to 30 m	1.0 mm <sup>2</sup>	11 μA <sub>PP</sub>
309774-xx	<b>VBK</b> , PUR, Ø 8 mm, 3 x (2 x 0.16 mm <sup>2</sup> ) + 2 x 1.0 mm <sup>2</sup> ; 9-pin M23 coupling (female) and 9-pin M23 connector (male) 	1 m to 30 m	1.0 mm <sup>2</sup>	11 μA <sub>PP</sub>
309775-xx	<b>VBK</b> Ø 14 mm, 3 x (2 x 0.16 mm <sup>2</sup> ) + 2 x 1.0 mm <sup>2</sup> ; 9-pin M23 coupling (female) and 9-pin M23 connector (male) 	1 m to 20 m	1.0 mm <sup>2</sup>	11 μA <sub>PP</sub>











ID		Length	Ap	Use with
309776-xx	<b>VBK</b> Ø 8 mm, 3 x (2 x 0.16 mm <sup>2</sup> ) + 2 x 1.0 mm <sup>2</sup> ; stripped cable end and 9-pin M23 connector (male) 	1 m to 30 m	1.0 mm <sup>2</sup>	11 µApp
309777-xx	<b>VBK</b> Ø 8 mm, 4 x (2 x 0.16 mm <sup>2</sup> ) + 4 x 0.5 mm <sup>2</sup> ; 12-pin M23 connector (female) and stripped cable end 	1 m to 50 m	2 x 0.5 mm <sup>2</sup>	1 V <sub>PP</sub> TTL HTL
309778-xx	<b>VBK</b> Ø 8 mm, 4 x (2 x 0.16 mm <sup>2</sup> ) + 4 x 0.5 mm <sup>2</sup> + (4 x 0.16 mm <sup>2</sup> ); 17-pin M23 connector (female) and stripped cable end 	1 m to 50 m	2 x 0.5 mm <sup>2</sup>	EnDat01 EnDat02 SSI...
309780-xx	<b>VBK</b> Ø 8 mm, 3 x (2 x 0.16 mm <sup>2</sup> ) + 2 x 1.0 mm <sup>2</sup> ; 9-pin M23 coupling (female) and stripped cable end 	1 m to 30 m	1.0 mm <sup>2</sup>	11 µApp
309783-xx	<b>APK</b> Ø 8 mm, 4 x (2 x 0.16 mm <sup>2</sup> ) + 4 x 0.5 mm <sup>2</sup> ; 12-pin M23 coupling (female) and 15-pin D-sub connector (female) 	1 m to 50 m	2 x 0.5 mm <sup>2</sup>	1 V <sub>PP</sub> TTL HTL
309784-xx	<b>APK</b> Ø 8 mm, 4 x (2 x 0.16 mm <sup>2</sup> ) + 4 x 0.5 mm <sup>2</sup> ; 12-pin M23 coupling (female) and 15-pin D-sub connector (male) 	0.5 m to 25 m	2 x 0.5 mm <sup>2</sup>	1 V <sub>PP</sub> TTL HTL
309785-xx	<b>APK</b> Ø 8 mm, 3 x (2 x 0.16 mm <sup>2</sup> ) + 2 x 1.0 mm <sup>2</sup> ; 9-pin M23 coupling (female) and 9-pin D-sub connector (male) 	0.5 m to 10 m	1.0 mm <sup>2</sup>	11 µApp
310126-xx	<b>APK</b> Ø 10 mm, 6 x (2 x 0.19 mm <sup>2</sup> ); 12-pin LS connector (large) and 12-pin M23 connector (male) 	1 m to 9 m	2 x 0.19 mm <sup>2</sup>	1 V <sub>PP</sub> TTL
310127-xx	<b>APK</b> Ø 6 mm, 6 x (2 x 0.19 mm <sup>2</sup> ); 12-pin LS connector (large) and 12-pin M23 connector (male) 	1 m to 9 m	2 x 0.19 mm <sup>2</sup>	1 V <sub>PP</sub> TTL
310128-xx	<b>APK</b> Ø 6 mm, 6 x (2 x 0.19 mm <sup>2</sup> ); 12-pin LS connector (large) and 12-pin M23 coupling (male) 	1 m to 9 m	2 x 0.19 mm <sup>2</sup>	1 V <sub>PP</sub> TTL
310131-xx	<b>VBK</b> Ø 6 mm, 6 x (2 x 0.19 mm <sup>2</sup> ); 12-pin LS connector (large) and stripped cable end 	1 m to 9 m	2 x 0.19 mm <sup>2</sup>	1 V <sub>PP</sub> TTL
310193-xx	<b>VBK</b> Ø 8 mm, 3 x (2 x 0.14 mm <sup>2</sup> ) + 2 x 0.5 mm <sup>2</sup> ; 7-pin M23 connector (female) and stripped cable end 	3 m to 40 m	0.5 mm <sup>2</sup>	TS/TT
310194-xx	<b>VBK</b> Ø 8 mm, 4 x (2 x 0.16 mm <sup>2</sup> ) + 4 x 0.5 mm <sup>2</sup> ; 7-pin M23 mounted coupling (female) and stripped cable end 	1 m to 30 m	0.5 mm <sup>2</sup>	TS/TT









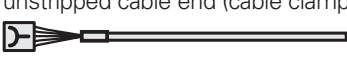
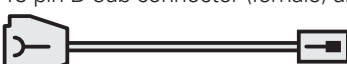















ID		Length	A <sub>P</sub>	Use with
310196-xx	<b>APK</b> Ø 8 mm, 4 x (2 x 0.16 mm <sup>2</sup> ) + 4 x 0.5 mm <sup>2</sup> ; 12-pin M23 connector (female) and 15-pin D-sub connector (male) 	0.5 m to 25 m	2 x 0.5 mm <sup>2</sup>	1 V <sub>PP</sub> TTL HTL
310197-xx	<b>APK</b> Ø 8 mm, 3 x (2 x 0.14 mm <sup>2</sup> ) + 2 x 0.5 mm <sup>2</sup> ; 7-pin M23 connector (female) and 15-pin D-sub connector (male) 	1 m to 25 m	0.5 mm <sup>2</sup>	TS/TT
310199-xx	<b>APK</b> Ø 8 mm, 4 x (2 x 0.16 mm <sup>2</sup> ) + 4 x 0.5 mm <sup>2</sup> ; 12-pin M23 connector (female) and 15-pin D-sub connector (female) 	1 m to 50 m	2 x 0.5 mm <sup>2</sup>	1 V <sub>PP</sub> TTL HTL
313119-01	<b>PUR adapter cable</b> Ø 6 mm, 6 x (2 x 0.19 mm <sup>2</sup> ); conversion from 11 µA <sub>PP</sub> → 1 V <sub>PP</sub> ; 15-pin D-sub coupling (male) and 15-pin D-sub connector (female) 	1 m	0.19 mm <sup>2</sup>	11 µA <sub>PP</sub>
323897-xx	<b>VBK</b> Ø 8 mm, 4 x (2 x 0.16 mm <sup>2</sup> ) + 4 x 0.5 mm <sup>2</sup> + (4 x 0.16 mm <sup>2</sup> ); 17-pin M23 connector (female) and 17-pin M23 coupling (male) 	1 m to 50 m	2 x 0.5 mm <sup>2</sup>	EnDat01 EnDat02 1 V <sub>PP</sub> + Z1 SSI...
324544-xx	<b>APK</b> Ø 8 mm, 4 x (2 x 0.16 mm <sup>2</sup> ) + 4 x 0.5 mm <sup>2</sup> + (4 x 0.16 mm <sup>2</sup> ); 17-pin M23 connector (female) and 15-pin D-sub connector (male) 	1 m to 25 m	2 x 0.5 mm <sup>2</sup>	EnDat01 EnDat02
331693-xx	<b>APK</b> Ø 8 mm, 4 x (2 x 0.16 mm <sup>2</sup> ) + 4 x 0.5 mm <sup>2</sup> ; 15-pin D-sub connector (female) and 12-pin M23 connector (male) 	1 m to 50 m	2 x 0.5 mm <sup>2</sup>	1 V <sub>PP</sub> TTL
332115-xx	<b>APK</b> Ø 8 mm, 4 x (2 x 0.16 mm <sup>2</sup> ) + 4 x 0.5 mm <sup>2</sup> + (4 x 0.16 mm <sup>2</sup> ); 17-pin M23 connector (female) and 15-pin D-sub connector (female) 	1 m to 50 m	2 x 0.5 mm <sup>2</sup>	EnDat01 EnDat02 SSI...
332199-01	<b>AGK ERN 1387</b> , Ø 4.5 mm EPG (with shield crimping Ø 6.1 mm), 16 x 0.057 mm <sup>2</sup> and polyolefin wires, 2 x 0.25 mm <sup>2</sup> for temperature sensor; 14-pin PCB connector and 17-pin M23 angle flange socket (male); collective package upon request 	0.3 m	2 x 0.057 mm <sup>2</sup>	1 V <sub>PP</sub>
332200-01 332200-04	<b>AGK ERN 1387</b> , Ø 4.5 mm EPG (with shield crimping Ø 6.1 mm) 16 x 0.057 mm <sup>2</sup> ; 14-pin PCB connector and unstripped cable end; collective package upon request 	0.3 m 1 m	2 x 0.057 mm <sup>2</sup>	1 V <sub>PP</sub>
332201-01	<b>AGK ECN 1313/EQN 1325/ECI 1319/EQI 1331</b> , Ø 4.5 mm EPG (with shield crimping Ø 6.1 mm), 16 x 0.057 mm <sup>2</sup> and polyolefin wires, 2 x 0.25 mm <sup>2</sup> for temperature sensor; 12-pin PCB connector and 17-pin M23 angle flange socket (male); collective package upon request 	0.3 m	2 x 0.057 mm <sup>2</sup>	EnDat01



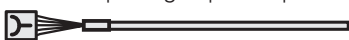



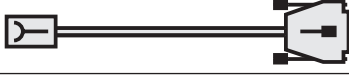





ID		Length	Ap	Use with
332202-01	<b>AGK ECN 1313/EQN 1325/ECI 1319/EQI 1331</b> , Ø 4.5 mm EPG (with shield crimping Ø 6.1 mm), 16 x 0.057 mm <sup>2</sup> ; 12-pin PCB connector and unstripped cable end; collective package upon request 	0.3 m	2 x 0.057 mm <sup>2</sup>	EnDat01
332433-xx	<b>VBK</b> Ø 8 mm, 4 x (2 x 0.16 mm <sup>2</sup> ) + 4 x 0.5 mm <sup>2</sup> ; 15-pin D-sub connector (female) and stripped cable end 	1 m to 50 m	2 x 0.5 mm <sup>2</sup>	1 V <sub>PP</sub> TTL
333276-01	<b>AGK ERN 1381/ERN 1321</b> , Ø 4.5 mm EPG (with shield crimping Ø 6.1 mm), 16 x 0.057 mm <sup>2</sup> ; 12-pin PCB connector and unstripped cable end; collective package upon request 	0.3 m	2 x 0.057 mm <sup>2</sup>	1 V <sub>PP</sub> TTL
335074-xx	<b>VBK</b> Ø 8 mm, 4 x (2 x 0.16 mm <sup>2</sup> ) + 4 x 0.5 mm <sup>2</sup> ; 15-pin D-sub connector (female) and 15-pin D-sub connector (male) 	1 m to 50 m	2 x 0.5 mm <sup>2</sup>	1 V <sub>PP</sub> TTL
335077-xx	<b>APK</b> Ø 8 mm, 4 x (2 x 0.16 mm <sup>2</sup> ) + 4 x 0.5 mm <sup>2</sup> ; 15-pin D-sub connector (female) and 15-pin D-sub connector (female) 	1 m to 50 m	2 x 0.5 mm <sup>2</sup>	1 V <sub>PP</sub> TTL
335332-xx	<b>APK</b> Ø 8 mm, 4 x (2 x 0.16 mm <sup>2</sup> ) + 4 x 0.5 mm <sup>2</sup> ; 7-pin M23 mounted coupling (female) and 9-pin D-sub connector (male) 	0.5 m to 40 m	0.5 mm <sup>2</sup>	TS/TT
336376-xx	<b>APK</b> Ø 8 mm, 4 x (2 x 0.16 mm <sup>2</sup> ) + 4 x 0.5 mm <sup>2</sup> + (4 x 0.16 mm <sup>2</sup> ); 17-pin M23 connector (female) and 25-pin D-sub connector (female) 	1 m to 50 m	2 x 0.5 mm <sup>2</sup>	EnDat01 EnDat02 SSI...
336847-xx	<b>VBK</b> Ø 8 mm, 4 x (2 x 0.16 mm <sup>2</sup> ) + 4 x 0.5 mm <sup>2</sup> + (4 x 0.16 mm <sup>2</sup> ); 17-pin M23 connector (female) and 17-pin M23 coupling (male) 	1 m to 50 m	2 x 0.5 mm <sup>2</sup>	1 V <sub>PP</sub> + Z1
340302-xx	<b>VBK</b> Ø 8 mm, 4 x (2 x 0.16 mm <sup>2</sup> ) + 4 x 0.5 mm <sup>2</sup> + (4 x 0.16 mm <sup>2</sup> ); 17-pin M23 connector (female) and 17-pin M23 coupling (male) 	1 m to 50 m	2 x 0.5 mm <sup>2</sup>	EnDat01 EnDat02 SSI...
341369-01	<b>AGK ERN 1326</b> , Ø 4.5 mm EPG (with shield crimping Ø 6.1 mm), 16 x 0.057 mm <sup>2</sup> ; 16-pin PCB connector and unstripped cable end; collective package upon request 	0.3 m	2 x 0.057 mm <sup>2</sup>	TTL
344228-xx	<b>APK</b> Ø 6 mm, 6 x (2 x 0.19 mm <sup>2</sup> ); 14-pin M12 coupling and 12-pin M23 connector (male) 	1 m to 9 m	2 x 0.19 mm <sup>2</sup>	1 V <sub>PP</sub> TTL
344451-xx	<b>APK</b> Ø 10 mm, 6 x (2 x 0.19 mm <sup>2</sup> ); 14-pin M12 coupling and 12-pin M23 connector (male) 	1 m to 9 m	2 x 0.19 mm <sup>2</sup>	1 V <sub>PP</sub> TTL





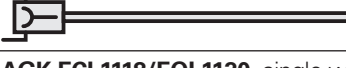

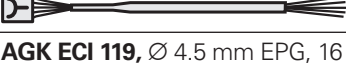



ID		Length	A <sub>P</sub>	Use with
346439-01	<b>AGK ERO 14x0</b> , PUR Ø 4.5 mm (with shield crimping Ø 4.3 mm), 4 x (2 x 0.05 mm <sup>2</sup> ) + 4 x 0.16 mm <sup>2</sup> ; 12-pin PCB connector and unstripped cable end (cable clamp included); collective package upon request 	1 m	2 x 0.16 mm <sup>2</sup>	1 V <sub>PP</sub> TTL
349314-xx	<b>VBK</b> Ø 8 mm, 1 x (4 x 0.16 mm <sup>2</sup> ) + 4 x 1.0 mm <sup>2</sup> ; 17-pin M23 connector (female) and 17-pin M23 coupling (male) 	1 m to 15 m	2 x 1.0 mm <sup>2</sup>	Fanuc... Mit...
349687-xx	<b>APK</b> Ø 6 mm, 6 x (2 x 0.19 mm <sup>2</sup> ); 15-pin D-sub connector (female) and 15-pin D-sub connector (female) 	1 m to 7 m	2 x 0.19 mm <sup>2</sup>	1 V <sub>PP</sub> TTL
352611-xx	<b>APK</b> Ø 4.5 mm, 4 x (2 x 0.05 mm <sup>2</sup> ) + 4 x 0.16 mm <sup>2</sup> ; 14-pin M12 coupling and 12-pin M23 connector (male) 	1 m to 9 m	2 x 0.16 mm <sup>2</sup>	1 V <sub>PP</sub> TTL
354319-xx	<b>VBK</b> Ø 6 mm, 6 x (2 x 0.19 mm <sup>2</sup> ); 14-pin M12 coupling and stripped cable end 	1 m to 15 m	2 x 0.19 mm <sup>2</sup>	1 V <sub>PP</sub> TTL
354379-xx	<b>VBK</b> Ø 8 mm, 6 x 2 x 0.16 mm <sup>2</sup> + 4 x 0.5 mm <sup>2</sup> ; 15-pin D-sub connector (female) and 15-pin D-sub connector (male) 	1 m to 20 m	2 x 0.5 mm <sup>2</sup>	1 V <sub>PP</sub> TTL
354411-xx	<b>VBK</b> Ø 8 mm, 6 x 2 x 0.16 mm <sup>2</sup> + 4 x 0.5 mm <sup>2</sup> ; 15-pin D-sub connector (female) and stripped cable end 	1 m to 20 m	2 x 0.5 mm <sup>2</sup>	1 V <sub>PP</sub> TTL
355186-xx	<b>VBK</b> Ø 6 mm, 6 x (2 x 0.19 mm <sup>2</sup> ); 15-pin D-sub connector (female) and 15-pin D-sub connector (male) 	1 m to 7 m	2 x 0.19 mm <sup>2</sup>	1 V <sub>PP</sub> TTL
355209-xx	<b>VBK</b> Ø 6 mm, 6 x (2 x 0.19 mm <sup>2</sup> ); 15-pin D-sub connector (female) and stripped cable end 	1 m to 7 m	2 x 0.19 mm <sup>2</sup>	1 V <sub>PP</sub> TTL
355215-xx	<b>APK</b> Ø 6 mm, 6 x (2 x 0.19 mm <sup>2</sup> ); 15-pin D-sub connector (female) and 12-pin M23 connector (male) 	1 m to 7 m	2 x 0.19 mm <sup>2</sup>	1 V <sub>PP</sub> TTL
355397-xx	<b>VBK</b> Ø 6 mm, 6 x (2 x 0.09 mm <sup>2</sup> ) + 4 x 0.16 mm <sup>2</sup> ; 15-pin D-sub connector (female) and 15-pin D-sub connector (male) 	1 m to 7 m	2 x 0.16 mm <sup>2</sup>	1 V <sub>PP</sub> TTL
355398-xx	<b>VBK</b> Ø 6 mm, 6 x (2 x 0.09 mm <sup>2</sup> ) + 4 x 0.16 mm <sup>2</sup> ; 15-pin D-sub connector (female) and stripped cable end 	1 m to 7 m	2 x 0.16 mm <sup>2</sup>	1 V <sub>PP</sub> TTL

ID		Length	Ap	Use with
360645-xx	<b>APK</b> Ø 6 mm, 6 x (2 x 0.19 mm <sup>2</sup> ); 14-pin M12 coupling and 12-pin M23 coupling (male) 	1 m to 9 m	2 x 0.19 mm <sup>2</sup>	1 V <sub>PP</sub> TTL
360974-xx	<b>APK</b> Ø 6 mm, 6 x (2 x 0.19 mm <sup>2</sup> ); 14-pin M12 coupling and 15-pin D-sub connector (female) 	1 m to 15 m	2 x 0.19 mm <sup>2</sup>	1 V <sub>PP</sub> TTL
364914-01	<b>Adapter connector</b> , conversion from 1 V <sub>PP</sub> → 11 µA <sub>PP</sub> ; 12-pin M23 connector (female) and 9-pin M23 connector (male) 	–	–	1 V <sub>PP</sub>
364914-02	<b>Adapter connector</b> , conversion from 1 V <sub>PP</sub> → 11 µA <sub>PP</sub> ; 12-pin M23 coupling (female) and 9-pin M23 connector (male) 	–	–	1 V <sub>PP</sub>
366419-xx	<b>APK</b> Ø 6 mm, 2 x (2 x 0.16 mm <sup>2</sup> ) + 4 x 0.5 mm <sup>2</sup> ; 15-pin D-sub connector (female) and 20-pin Mini Delta Ribbon connector (male) 	1 m to 30 m	2 x 0.5 mm <sup>2</sup>	Mit..
366964-xx	<b>V.24 cable (RS 232)</b> for ND 280, PUR Ø 6 mm, 6 x (2 x 0.19 mm <sup>2</sup> ); 9-pin D-sub connector (male) and 9-pin D-sub connector (female) 	3 m 5 m 10 m	2 x 0.19 mm <sup>2</sup>	ND
367958-xx	<b>APK</b> Ø 6 mm, 2 x (2 x 0.16 mm <sup>2</sup> ) + 4 x 0.5 mm <sup>2</sup> ; 17-pin M23 connector (female) and 20-pin Mini Delta Ribbon connector (male) 	1 m to 25 m	2 x 0.5 mm <sup>2</sup>	Mit...
368017-xx	<b>V.24 cable (RS 232)</b> for ND 280, PVC Ø 7.1 mm, 8 x 0.25 mm <sup>2</sup> ; 25-pin D-sub connector (male) and 9-pin D-sub connector (female) 	3 m 5 m 10 m	0.25 mm <sup>2</sup>	ND
368172-xx	<b>APK</b> Ø 8 mm, 3 x (2 x 0.16 mm <sup>2</sup> ) + 2 x 1.0 mm <sup>2</sup> ; 9-pin M23 coupling (female) and 15-pin D-sub connector (female) 	1 m to 10 m	1.0 mm <sup>2</sup>	11 µA <sub>PP</sub>
368330-xx	<b>VBK</b> Ø 6 mm, 1 x (4 x 0.16 mm <sup>2</sup> ) + 4 x 0.34 mm <sup>2</sup> ; 8-pin M12 connector (female) and 8-pin M12 coupling (male) 	1 m to 50 m	2 x 0.34 mm <sup>2</sup>	TS/TT
372164-01	<b>AGK ERO 12x5, ERP 880</b> , PUR Ø 4.5 mm (with shield crimping Ø 4.3 mm), 4 x (2 x 0.05 mm <sup>2</sup> ) + 4 x 0.16 mm <sup>2</sup> ; 12-pin PCB connector (Hirose) and unstripped cable end (cable clamp included); collective package upon request 	1 m	2 x 0.16 mm <sup>2</sup>	1 V <sub>PP</sub> TTL
372978-xx	<b>APK</b> Ø 8 mm, 4 x (2 x 0.16 mm <sup>2</sup> ) + 4 x 0.5 mm <sup>2</sup> ; 15-pin D-sub connector (female) and 12-pin M23 coupling (male) 	1 m to 30 m	2 x 0.5 mm <sup>2</sup>	1 V <sub>PP</sub> TTL

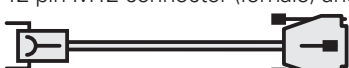

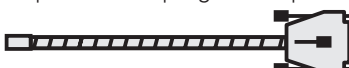









ID		Length	A <sub>P</sub>	Use with
372979-xx	<b>APK</b> Ø 6 mm, 6 x (2 x 0.19 mm <sup>2</sup> ); 15-pin D-sub connector (female) and 12-pin M23 coupling (male) 	1 m to 7 m	2 x 0.19 mm <sup>2</sup>	1 V <sub>PP</sub> TTL
373289-xx	<b>VBK</b> Ø 6 mm, 1 x (4 x 0.16 mm <sup>2</sup> ) + 4 x 0.34 mm <sup>2</sup> ; 8-pin M12 right-angle connector (female) and 8-pin M12 coupling (male) 	1 m to 50 m	2 x 0.34 mm <sup>2</sup>	TS/TT
387287-xx	<b>APK</b> Ø 6 mm, 6 x (2 x 0.19 mm <sup>2</sup> ); 14-pin M12 coupling and 15-pin D-sub connector (male) 	1 m to 15 m	2 x 0.19 mm <sup>2</sup>	1 V <sub>PP</sub> TTL
509667-xx	<b>APK</b> Ø 8 mm, 4 x (2 x 0.16 mm <sup>2</sup> ) + 4 x 0.5 mm <sup>2</sup> + (4 x 0.16 mm <sup>2</sup> ); 17-pin M23 connector (female) and 25-pin D-sub connector (female) 	1 m to 50 m	2 x 0.5 mm <sup>2</sup>	EnDat01 EnDat02
517375-xx	<b>APK</b> Ø 4.5 mm, 4 x (2 x 0.05 mm <sup>2</sup> ) + 1 x 0.05 mm <sup>2</sup> ; 8-pin M9 connector (female) and 7-pin M23 coupling (male) 	1 m to 5 m	0.05 mm <sup>2</sup>	TS/TT
517376-xx	<b>APK</b> Ø 4.5 mm, 4 x (2 x 0.05 mm <sup>2</sup> ) + 1 x 0.05 mm <sup>2</sup> ; 8-pin M9 connector (female) and 15-pin D-sub connector (male) 	6 m to 30 m	0.05 mm <sup>2</sup>	TS/TT
533631-xx	<b>APK</b> Ø 6 mm, 6 x (2 x 0.19 mm <sup>2</sup> ); 14-pin M12 coupling and 17-pin M23 coupling (male) 	1 m to 9 m	2 x 0.19 mm <sup>2</sup>	EnDat01 EnDat02 SSI...
534855-xx	<b>APK</b> Ø 8 mm, 2 x (2 x 0.16 mm <sup>2</sup> ) + 4 x 1.0 mm <sup>2</sup> ; 17-pin M23 connector (female) and 15-pin Mini Delta Ribbon connector (female) 	1 m to 30 m	2 x 1.0 mm <sup>2</sup>	Fanuc..
539878-xx	<b>APK</b> Ø 10 mm, 6 x (2 x 0.19 mm <sup>2</sup> ); 14-pin M12 coupling and 15-pin D-sub connector (female) 	1 m to 20 m	2 x 0.19 mm <sup>2</sup>	1 V <sub>PP</sub> TTL
540660-05	<b>VBK</b> , PVC, Ø 5.1 mm, 6 x 0.25 mm <sup>2</sup> ; for the communication between the ND 1000/ND 2000 and PC with QUADRA-CHEK Wedge; 9-pin D-sub connectors (female) 	3 m	–	ND
556558-xx	<b>APK</b> Ø 8 mm, 4 x (2 x 0.16 mm <sup>2</sup> ) + 4 x 0.5 mm <sup>2</sup> ; 12-pin M23 connector (female) and 15-pin Mini Delta Ribbon connector (female) 	1 m to 30 m	2 x 0.5 mm <sup>2</sup>	Fanuc..
558362-xx	<b>APK</b> Ø 10 mm, 6 x (2 x 0.19 mm <sup>2</sup> ); 14-pin M12 coupling and 17-pin M23 coupling (male) 	1 m to 9 m	2 x 0.19 mm <sup>2</sup>	EnDat01 EnDat02 SSI...









ID		Length	Ap	Use with
558714-xx	<b>APK</b> Ø 6 mm, 6 x (2 x 0.19 mm <sup>2</sup> ); 14-pin M12 coupling and 15-pin D-sub connector (female) 	1 m to 20 m	2 x 0.19 mm <sup>2</sup>	EnDat01 EnDat02 SSI...
558727-xx	<b>APK</b> Ø 6 mm, 6 x (2 x 0.19 mm <sup>2</sup> ); 14-pin M12 coupling and 25-pin D-sub connector (female) 	1 m to 20 m	2 x 0.19 mm <sup>2</sup>	EnDat01 EnDat02 SSI...
572822-xx	<b>APK</b> Ø 8 mm, 4 x (2 x 0.16 mm <sup>2</sup> ) + 4 x 0.5 mm <sup>2</sup> ; 12-pin M23 coupling (female) and 15-pin Mini Delta Ribbon connector (female) 	1 m to 30 m	2 x 0.5 mm <sup>2</sup>	Fanuc..
573661-xx	<b>APK</b> Ø 8 mm, 2 x (2 x 0.16 mm <sup>2</sup> ) + 4 x 1.0 mm <sup>2</sup> ; 17-pin M23 connector (female) and 10-pin Mini Delta Ribbon connector (female) 	1 m to 30 m	2 x 1.0 mm <sup>2</sup>	Mit..
588552-xx	<b>APK</b> Ø 10 mm, 6 x (2 x 0.19 mm <sup>2</sup> ); 12-pin LS connector (large) and 15-pin D-sub connector (female) 	1 m to 9 m	2 x 0.19 mm <sup>2</sup>	1 V <sub>PP</sub> TTL
605090-01 605090-02	<b>AGK ECN 1113/EQN 1125</b> , Ø 4.5 mm EPG (with shield crimping Ø 4.3 mm), 16 x 0.057 mm <sup>2</sup> ; 15-pin PCB connector and unstripped cable end; collective package upon request 	0.3 m 2 m	2 x 0.057 mm <sup>2</sup>	EnDat01
606079-01	<b>AGK ECN 1113/EQN 1125</b> , Ø 4.5 mm EPG (with shield crimping Ø 4.3 mm), 16 x 0.057 mm <sup>2</sup> and polyolefin wires, 2 x 0.25 mm <sup>2</sup> for temperature sensor; 15-pin PCB connector and 17-pin M23 angle flange socket (male) 	0.3 m	2 x 0.057 mm <sup>2</sup>	EnDat01
606317-xx	<b>VBK</b> Ø 6 mm, 1 x (4 x 0.16 mm <sup>2</sup> ) + 4 x 0.34 mm <sup>2</sup> ; 8-pin M12 right-angle connector (female) and unstripped cable end 	1 m to 50 m	2 x 0.34 mm <sup>2</sup>	TS/TT
617484-xx	<b>APK in braided shield</b> Ø 6.6 mm, 6 x (2 x 0.19 mm <sup>2</sup> ); 14-pin M12 coupling and 9-pin D-sub connector (male) 	1 m to 9 m	2 x 0.19 mm <sup>2</sup>	TTL
617513-xx	<b>APK</b> Ø 8 mm, 4 x (2 x 0.16 mm <sup>2</sup> ) + 4 x 0.5 mm <sup>2</sup> ; 12-pin M23 coupling (female) and 9-pin D-sub connector (male) 	1 m to 30 m	2 x 0.5 mm <sup>2</sup>	TTL
621742-01	<b>AGK ECI 11xx/ECI 13xx/EQI 11xx/EQI 13xx/ExN 11xx/ExN 13xx</b> , Ø 4.5 mm EPG 16 x 0.057 mm <sup>2</sup> ; 12-pin PCB connector with strain relief and 15-pin D-sub connector (male), including three 12-pin adapter connectors and three 15-pin adapter connectors; testing cable for PWM 21 	2 m	2 x 0.057 mm <sup>2</sup>	EnDat01 EnDat22 DQ...







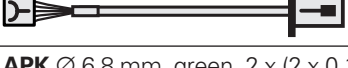
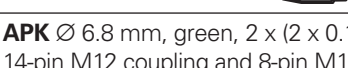
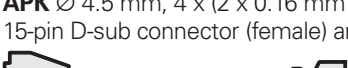
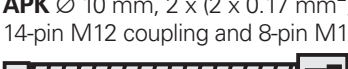



ID		Length	A <sub>p</sub>	Use with
626015-xx	<b>APK</b> Ø 8 mm, 4 x (2 x 0.16 mm <sup>2</sup> ) + 4 x 0.5 mm <sup>2</sup> ; 12-pin M23 connector (female) and 9-pin D-sub connector (male) 	1 m to 50 m	2 x 0.5 mm <sup>2</sup>	TTL
628184-xx	<b>APK</b> Ø 6 mm, 2 x (2 x 0.16 mm <sup>2</sup> ) + 4 x 0.5 mm <sup>2</sup> ; 15-pin D-sub connector (female) and 15-pin Mini Delta Ribbon connector (female) 	1 m to 30 m	2 x 0.5 mm <sup>2</sup>	Fanuc...
630856-xx	<b>APK</b> Ø 6 mm, 4 x (2 x 0.16 mm <sup>2</sup> ) + 4 x 0.5 mm <sup>2</sup> ; 15-pin D-sub connector (female) and 10-pin Mini Delta Ribbon connector (female) 	1 m to 30 m	2 x 0.5 mm <sup>2</sup>	Mit...
633608-xx	<b>APK</b> Ø 4.5 mm; 8-pin M9 connector (female) and 15-pin D-sub connector (male) 	1 m to 30 m	0.09 mm <sup>2</sup>	TS/TT
633611-xx	<b>APK</b> Ø 6 mm, 6 x (2 x 0.19 mm <sup>2</sup> ); 7-pin M23 connector (female) and 15-pin D-sub connector (male) 	1 m to 25 m	0.09 mm <sup>2</sup>	TS/TT
633613-xx	<b>APK</b> Ø 8 mm, 4 x (2 x 0.16 mm <sup>2</sup> ) + 4 x 0.5 mm <sup>2</sup> ; 6-pin push-pull flange socket and 15-pin D-sub connector (male) 	1 m to 20 m	0.19 mm <sup>2</sup>	TS/TT
633616-xx	<b>APK</b> Ø 6 mm, 6 x (2 x 0.19 mm <sup>2</sup> ); 7-pin M23 mounted coupling (female) and 15-pin D-sub connector (male) 	1 m to 40 m	0.09 mm <sup>2</sup>	TS/TT
633811-xx	<b>VBK</b> Ø 6 mm, 6 x (2 x 0.09 mm <sup>2</sup> ) + 4 x 0.16 mm <sup>2</sup> ; 15-pin D-sub connector (female) and 15-pin D-sub connector (male) 	1 m to 10 m	2 x 0.16 mm <sup>2</sup>	1 V <sub>PP</sub> TTL
634265-xx	<b>VBK</b> Ø 6 mm, 1 x (4 x 0.16 mm <sup>2</sup> ) + 4 x 0.34 mm <sup>2</sup> ; 8-pin M12 connector (female) and unstripped cable end 	1 m to 50 m	2 x 0.34 mm <sup>2</sup>	TS/TT
640030-01	<b>AGK ECI 1118/EQI 1130</b> , single wires with heat shrink tubing (without shield), 12 x 0.16 mm <sup>2</sup> ; 15-pin PCB connector and stripped cable end; collective package upon request 	0.15 m	2 x 0.16 mm <sup>2</sup>	EnDat01
640055-01	<b>AGK EBI 1135</b> , single wires with heat shrink tubing (without shield), 8 x 0.16 mm <sup>2</sup> ; 15-pin PCB connector and stripped cable end; collective package upon request 	0.15 m	2 x 0.16 mm <sup>2</sup>	EnDat22
640067-N3	<b>AGK ECI 119</b> , Ø 4.5 mm EPG, 16 x 0.057 mm <sup>2</sup> ; 15-pin PCB connector and unstripped cable end (cable clamp mounted); collective package upon request 	0.3 m	2 x 0.057 mm <sup>2</sup>	EnDat01











ID		Length	A <sub>p</sub>	Use with
643450-xx	<b>APK</b> Ø 6 mm, 6 x (2 x 0.19 mm <sup>2</sup> ); 12-pin M12 quick connector and 17-pin M23 coupling (male) 	1 m to 20 m	2 x 0.19 mm <sup>2</sup>	EnDat02
653231-xx	<b>APK</b> Ø 8 mm, 3 x (2 x 0.16 mm <sup>2</sup> ) + 2 x 1.0 mm <sup>2</sup> ; 9-pin M23 coupling (female) and 15-pin D-sub connector (male) 	0.2 m 1 m to 10 m	1.0 mm <sup>2</sup>	11 µApp
660042-xx	<b>VBK</b> Ø 10 mm, 1 x (4 x 0.16 mm <sup>2</sup> ) + 4 x 0.34 mm <sup>2</sup> ; 8-pin M12 connector (female) and 8-pin M12 coupling (male) 	1 m to 50 m	0.34 mm <sup>2</sup>	TS/TT
663508-xx	<b>VBK</b> Ø 8 mm, 3 x (2 x 0.14 mm <sup>2</sup> ) + 2 x 0.5 mm <sup>2</sup> ; 15-pin D-sub connector (female) and 15-pin D-sub connector (male) 	1 m to 10 m	0.5 mm <sup>2</sup>	TS/TT
663511-xx	<b>VBK</b> Ø 8 mm, 4 x (2 x 0.16 mm <sup>2</sup> ) + 4 x 0.5 mm <sup>2</sup> ; 9-pin D-sub connector (female) and 9-pin D-sub connector (male) 	1 m to 10 m	0.5 mm <sup>2</sup>	TS/TT
663631-xx	<b>APK</b> Ø 6 mm, 6 x (2 x 0.19 mm <sup>2</sup> ); 12-pin M12 connector (female) and 15-pin D-sub connector (male) 	1 m to 20 m	0.19 mm <sup>2</sup>	TS/TT
664211-xx	<b>VBK</b> Ø 6 mm, 6 x (2 x 0.19 mm <sup>2</sup> ); 12-pin M12 connector (female) and 12-pin M12 coupling (male) 	1 m to 20 m	0.19 mm <sup>2</sup>	TS/TT
667343-01	<b>AGK ERN 1381/ERN 1321</b> , Ø 4.5 mm EPG (with shield crimping Ø 6.1 mm), 16 x 0.057 mm <sup>2</sup> and polyolefin wires, 2 x 0.25 mm <sup>2</sup> for temperature sensor; 12-pin PCB connector and 17-pin M23 angle flange socket (male) 	0.3 m	2 x 0.057 mm <sup>2</sup>	1 V <sub>PP</sub> TTL
672625-xx	<b>APK</b> Ø 10 mm, 6 x (2 x 0.19 mm <sup>2</sup> ); 14-pin M12 coupling and 15-pin D-sub connector (male) 	1 m to 20 m	2 x 0.19 mm <sup>2</sup>	1 V <sub>PP</sub> TTL
675582-xx	<b>VBK</b> Ø 8 mm, 4 x (2 x 0.16 mm <sup>2</sup> ) + 4 x 0.5 mm <sup>2</sup> + 4 x 0.16 mm <sup>2</sup> ; 15-pin D-sub connector (female) and 15-pin D-sub connector (male) 	1 m to 50 m	2 x 0.5 mm <sup>2</sup>	1 V <sub>PP</sub> + Z1
681186-xx	<b>VBK</b> Ø 6 mm, 6 x (2 x 0.19 mm <sup>2</sup> ); 12-pin M12 quick connector and unstripped cable end 	1 m to 20 m	2 x 0.19 mm <sup>2</sup>	EnDat02
701919-xx	<b>APK</b> Ø 8 mm, 3 x (2 x 0.14 mm <sup>2</sup> ) + 2 x 0.5 mm <sup>2</sup> ; 15-pin, 3-row D-sub connector (female) and 15-pin, 2-row D-sub connector (male) 	1 m to 20 m	0.5 mm <sup>2</sup>	TS/TT



















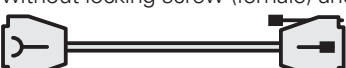



ID		Length	A <sub>P</sub>	Use with
716905-0A	<b>APK</b> Ø 8 mm, 3 x (2 x 0.16 mm <sup>2</sup> ) + 2 x 1.0 mm <sup>2</sup> ; 9-pin M23 coupling (female) and 9-pin D-sub connector (male) 	0.5 m	1.0 mm <sup>2</sup>	11 µAPP
727658-xx	<b>APK</b> Ø 6 mm, 6 x (2 x 0.19 mm <sup>2</sup> ); 12-pin M12 quick connector and 15-pin D-sub connector (female) 	1 m to 20 m	2 x 0.19 mm <sup>2</sup>	EnDat01 EnDat02
729681-xx	<b>APK</b> Ø 4.5 mm, 1 x (4 x 0.09 mm <sup>2</sup> ) + 4 x 0.16 mm <sup>2</sup> ; 12-pin quick connector and 8-pin M12 coupling (male) 	1 m to 20 m	2 x 0.16 mm <sup>2</sup>	EnDat22 Fanuc... Mit...
735210-xx	<b>APK</b> Ø 4.5 mm, 4 x (2 x 0.05 mm <sup>2</sup> ) + 4 x 0.16 mm <sup>2</sup> ; 14-pin M12 coupling and 9-pin D-sub connector (male) 	1 m to 9 m	2 x 0.16 mm <sup>2</sup>	TTL
735541-xx	<b>VBK</b> Ø 8 mm, 6 x (2 x 0.16 mm <sup>2</sup> ) + 4 x 0.5 mm <sup>2</sup> ; 15-pin D-sub connector (female) and 15-pin D-sub connector (male) with programming line for mounting of the LIP 2xx 	1 m to 6 m	2 x 0.5 mm <sup>2</sup>	1 V <sub>PP</sub> TTL
735784-01	<b>AGK ECI 1118</b> , single wires with heat shrink tubing (without shield), 6 x 0.16 mm <sup>2</sup> ; 15-pin PCB connector and stripped cable end; collective package upon request 	0.15 m	2 x 0.16 mm <sup>2</sup>	EnDat22
735961-xx	<b>APK</b> Ø 6 mm, 6 x (2 x 0.19 mm <sup>2</sup> ); 12-pin M12 quick connector and 25-pin D-sub connector (female) 	1 m to 20 m	2 x 0.19 mm <sup>2</sup>	EnDat02
738681-N5	<b>APK</b> Ø 8 mm, 3 x (2 x 0.16 mm <sup>2</sup> ) + 2 x 1.0 mm <sup>2</sup> ; 15-pin D-sub connector (male) and 15-pin D-sub connector (male); testing cable for PWM 21/PWT 100 	0.5 m	1.0 mm <sup>2</sup>	11 µAPP
738976-01	<b>AGK ERN 1123</b> single wires with heat shrink tubing (without shield), 14 x 0.16 mm <sup>2</sup> ; 15-pin PCB connector and stripped cable end; collective package upon request 	0.15 m	2 x 0.16 mm <sup>2</sup>	TTL
739098-N5	<b>APK</b> Ø 8 mm, 4 x (2 x 0.16 mm <sup>2</sup> ) + 4 x 0.5 mm <sup>2</sup> ; 15-pin D-sub connector (male) and 15-pin D-sub connector (male); testing cable for PWM 21/PWT 100 	0.5 m	2 x 0.5 mm <sup>2</sup>	1 V <sub>PP</sub> TTL HTL
745454-xx	<b>APK</b> Ø 6 mm, 1 x (4 x 0.16 mm <sup>2</sup> ) + 4 x 0.34 mm <sup>2</sup> ; 8-pin M12 connector (female) and 15-pin D-sub connector (male) 	1 m to 30 m	0.34 mm <sup>2</sup>	TS/TT
745894-xx	<b>VBK</b> Ø 8 mm, 2 x (2 x 0.24 mm <sup>2</sup> ) + 2 x (2 x 0.35 mm <sup>2</sup> ); 8-pin M12 connector (female) and 8-pin M12 coupling (male) 	1 m to 50 m	2 x 0.35 mm <sup>2</sup>	EnDat22 Fanuc... Mit... Pana... YEC...







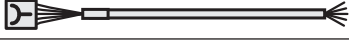



ID		Length	A <sub>p</sub>	Use with
747400-xx	<b>APK</b> , spiral cable, 4 x 0.14 mm <sup>2</sup> ; 8-pin M12 connector (female) and 6-pin push-pull connector 	1 m to 3 m	0.14 mm <sup>2</sup>	TS/TT
754232-xx	<b>APK</b> Ø 6 mm, 6 x (2 x 0.19 mm <sup>2</sup> ); 14-pin M12 coupling and 25-pin D-sub connector (female) 	1 m to 9 m	2 x 0.19 mm <sup>2</sup>	1 V <sub>PP</sub> TTL
754240-xx	<b>APK PUR with braided shield</b> Ø 6.6 mm, 6 x (2 x 0.19 mm <sup>2</sup> ); 14-pin M12 coupling and 25-pin D-sub connector (female) 	1 m to 9 m	2 x 0.19 mm <sup>2</sup>	1 V <sub>PP</sub> TTL
754299-xx	<b>APK</b> Ø 10 mm, 6 x (2 x 0.19 mm <sup>2</sup> ); 14-pin M12 coupling and 25-pin D-sub connector (female) 	1 m to 9 m	2 x 0.19 mm <sup>2</sup>	1 V <sub>PP</sub> TTL
758082-xx	<b>APK</b> Ø 8 mm, 4 x (2 x 0.16 mm <sup>2</sup> ) + 4 x 0.5 mm <sup>2</sup> ; 12-pin M23 connector (female) and 25-pin D-sub connector (female) 	1 m to 50 m	2 x 0.5 mm <sup>2</sup>	1 V <sub>PP</sub> TTL HTL
801285-xx	<b>VBK</b> Ø 6 mm, 6 x (2 x 0.19 mm <sup>2</sup> ); 12-pin M12 connector (female) and stripped cable end 	1 m to 20 m	0.19 mm <sup>2</sup>	TS/TT
804201-01	<b>AGK EBI 1135</b> , TPE single wires with net sleeve (without shield), 8 x 0.16 mm <sup>2</sup> ; 15-pin PCB connector and 8-pin M12 straight flange socket (male) 	0.15 m	2 x 0.16 mm <sup>2</sup>	EnDat22
805320-01	<b>AGK ECI 1118</b> , TPE single wires with net sleeve (without shield), 6 x 0.16 mm <sup>2</sup> ; 15-pin PCB connector and 8-pin M12 straight flange socket (male) 	0.15 m	2 x 0.16 mm <sup>2</sup>	EnDat22
805375-xx	<b>APK</b> Ø 6.8 mm, green, 2 x (2 x 0.17 mm <sup>2</sup> ) + 1 x (2 x 0.24 mm <sup>2</sup> ); 14-pin M12 encoder connector and RJ45 connector 	1 m to 30 m	0.24 mm <sup>2</sup>	DQ...
805452-xx	<b>APK</b> Ø 6.8 mm, green, 2 x (2 x 0.17 mm <sup>2</sup> ) + 1 x (2 x 0.24 mm <sup>2</sup> ); 14-pin M12 coupling and 8-pin M12 coupling (male) 	1 m to 20 m	0.24 mm <sup>2</sup>	DQ...
808976-xx	<b>APK</b> Ø 4.5 mm, 4 x (2 x 0.16 mm <sup>2</sup> ); 15-pin D-sub connector (female) and 6-pin Mini Delta Ribbon connector (female) 	1 m to 6 m	2 x 0.16 mm <sup>2</sup>	YEC...
816675-xx	<b>APK</b> Ø 10 mm, 2 x (2 x 0.17 mm <sup>2</sup> ) + 1 x (2 x 0.24 mm <sup>2</sup> ); 14-pin M12 coupling and 8-pin M12 coupling (male) 	1 m to 20 m	0.24 mm <sup>2</sup>	DQ...





ID		Length	A <sub>P</sub>	Use with
822504-xx	<b>VBK</b> Ø 6.8 mm, green, 2 x (2 x 0.17 mm <sup>2</sup> ) + 1 x (2 x 0.24 mm <sup>2</sup> ); 8-pin M12 connector (female) and 8-pin M12 coupling (male) 	1 m to 30 m	0.24 mm <sup>2</sup>	DQ...
823924-xx	<b>APK</b> Ø 6 mm, 1 x (4 x 0.16 mm <sup>2</sup> ) + 4 x 0.34 mm <sup>2</sup> ; 8-pin M12 connector (female) and 15-pin, 3-row D-sub connector (male) 	1 m to 20 m	2 x 0.34 mm <sup>2</sup>	TS/TT
825855-03	<b>AGK ECI 119 / EBI 135</b> , Ø 4.5 mm EPG (cable clamp mounted over crimp sleeve), 4 x (2 x 0.16 mm <sup>2</sup> ); 15-pin PCB connector and unstripped cable end 	0.3 m	2 x 0.16 mm <sup>2</sup>	EnDat22
1034913-03	<b>AGK ECI 1319/EQI 1331 Gen. 3/ECN 1325/EQN 1337</b> , Ø 3.7 mm EPG (with shield crimping Ø 6.1 mm), 1 x (4 x 0.06 mm <sup>2</sup> ) + 4 x 0.06 mm <sup>2</sup> ; 12-pin PCB connector and contact insert for 6-pin HMC 6 hybrid connecting element (male) 	0.3 m	2 x 0.06 mm <sup>2</sup>	EnDat22
1034953-15	<b>AGK ECN 1123/EQN 1135</b> , Ø 3.7 mm EPG, 1 x (4 x 0.06 mm <sup>2</sup> ) + 4 x 0.06 mm <sup>2</sup> ; 15-pin PCB connector and contact insert for 6-pin HMC 6 hybrid connecting element (male) 	0.15 m	0.06 mm <sup>2</sup>	EnDat22
1035387-03	<b>AGK ECI 1319/EQI 1331 Gen. 3/ECN 1325/EQN 1337</b> , Ø 3.7 mm EPG (with shield crimping Ø 6.1 mm), 1 x (4 x 0.06 mm <sup>2</sup> ) + 4 x 0.06 mm <sup>2</sup> with TPE wires, 2 x 0.16 mm <sup>2</sup> for temperature sensor; 16-pin PCB connector and contact insert for 6-pin HMC 6 hybrid connecting element (male) 	0.3 m	0.06 mm <sup>2</sup>	EnDat22
1035857-15	<b>AGK ECN 1123/EQN 1135</b> , Ø 3.7 mm EPG, 1 x (4 x 0.06 mm <sup>2</sup> ) + 4 x 0.06 mm <sup>2</sup> with TPE wires, 2 x 0.16 mm <sup>2</sup> for temperature sensor; 15-pin PCB connector and contact insert for 6-pin HMC 6 hybrid connecting element (male) 	0.15 m	0.06 mm <sup>2</sup>	EnDat22
1036361-xx	<b>APK</b> Ø 6 mm, 2 x (2 x 0.09 mm <sup>2</sup> ) + 2 x (2 x 0.16 mm <sup>2</sup> ); 12-pin quick connector and 8-pin M12 coupling (male) 	1 m to 20 m	2 x 0.16 mm <sup>2</sup>	EnDat22 Fanuc... Mit... Pana... YEC...
1036372-xx	<b>VBK</b> Ø 6 mm, 2 x (2 x 0.09 mm <sup>2</sup> ) + 2 x (2 x 0.16 mm <sup>2</sup> ); 8-pin M12 connector (female) and 8-pin M12 coupling (male) 	1 m to 30 m	2 x 0.16 mm <sup>2</sup>	EnDat22 Fanuc... Mit... Pana... YEC...
1036380-xx	<b>VBK</b> Ø 8 mm, 2 x (2 x 0.24 mm <sup>2</sup> ) + 2 x (2 x 0.35 mm <sup>2</sup> ); 8-pin M12 right-angle connector (female) and 8-pin M12 coupling (male) 	1 m to 50 m	2 x 0.35 mm <sup>2</sup>	EnDat22 Fanuc... Mit... Pana... YEC...

ID		Length	Ap	Use with
1036386-xx	<b>VBK</b> Ø 6 mm, 2 x (2 x 0.09 mm <sup>2</sup> ) + 2 x (2 x 0.16 mm <sup>2</sup> ); 8-pin M12 right-angle connector (female) and 8-pin M12 coupling (male) 	1 m to 30 m	2 x 0.16 mm <sup>2</sup>	EnDat22 Fanuc... Mit... Pana... YEC...
1036521-xx	<b>APK</b> Ø 6 mm, 2 x (2 x 0.09 mm <sup>2</sup> ) + 2 x (2 x 0.16 mm <sup>2</sup> ); 8-pin M12 connector (female) and 15-pin D-sub connector (female) 	1 m to 50 m	2 x 0.16 mm <sup>2</sup>	EnDat22
1036526-xx	<b>APK</b> Ø 6 mm, 2 x (2 x 0.09 mm <sup>2</sup> ) + 2 x (2 x 0.16 mm <sup>2</sup> ); 8-pin M12 connector (female) and 15-pin D-sub connector (male) 	1 m to 30 m	2 x 0.16 mm <sup>2</sup>	EnDat22 Fanuc... Mit... Pana... YEC...
1036537-xx	<b>APK</b> Ø 4.5 mm, 1 x (4 x 0.09 mm <sup>2</sup> ) + 4 x 0.16 mm <sup>2</sup> ; 14-pin M12 coupling and 8-pin M12 coupling (male) 	1 m to 20 m	2 x 0.16 mm <sup>2</sup>	EnDat22 Fanuc... Mit... Pana... YEC...
1036547-xx	<b>APK</b> Ø 6 mm, 2 x (2 x 0.09 mm <sup>2</sup> ) + 2 x (2 x 0.16 mm <sup>2</sup> ); 14-pin M12 coupling and 8-pin M12 coupling (male) 	1 m to 20 m	2 x 0.16 mm <sup>2</sup>	EnDat22 Fanuc... Mit... Pana... YEC...
1036549-xx	<b>APK</b> Ø 4.5 mm, 1 x (4 x 0.09 mm <sup>2</sup> ) + 4 x 0.16 mm <sup>2</sup> ; 14-pin M12 coupling and 17-pin M23 coupling (male) 	1 m to 9 m	2 x 0.16 mm <sup>2</sup>	EnDat22 Fanuc... Mit... Pana... YEC...
1036555-xx	<b>APK</b> Ø 6 mm, 2 x (2 x 0.09 mm <sup>2</sup> ) + 2 x (2 x 0.16 mm <sup>2</sup> ); 14-pin M12 coupling and 17-pin M23 coupling (male) 	1 m to 9 m	2 x 0.16 mm <sup>2</sup>	EnDat22 Fanuc... Mit... Pana... YEC...
1036724-xx	<b>APK</b> Ø 4.5 mm, 1 x (4 x 0.09 mm <sup>2</sup> ) + 4 x 0.16 mm <sup>2</sup> ; 14-pin M12 coupling and 15-pin Mini Delta Ribbon connector (female) 	1 m to 30 m	2 x 0.16 mm <sup>2</sup>	Fanuc...
1036726-xx	<b>APK</b> Ø 6 mm, 2 x (2 x 0.09 mm <sup>2</sup> ) + 2 x (2 x 0.16 mm <sup>2</sup> ); 14-pin M12 coupling and 15-pin Mini Delta Ribbon connector (female) 	1 m to 30 m	2 x 0.16 mm <sup>2</sup>	Fanuc...
1036736-xx	<b>APK</b> Ø 4.5 mm, 1 x (4 x 0.09 mm <sup>2</sup> ) + 4 x 0.16 mm <sup>2</sup> ; 14-pin M12 coupling and 20-pin Mini Delta Ribbon connector (male) 	1 m to 30 m	2 x 0.16 mm <sup>2</sup>	Mit...
1036737-xx	<b>APK</b> Ø 6 mm, 2 x (2 x 0.09 mm <sup>2</sup> ) + 2 x (2 x 0.16 mm <sup>2</sup> ); 14-pin M12 coupling and 20-pin Mini Delta Ribbon connector (male) 	1 m to 30 m	2 x 0.16 mm <sup>2</sup>	Mit...





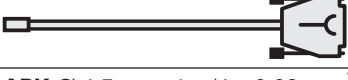
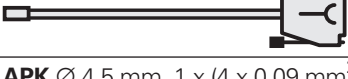
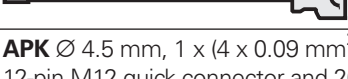
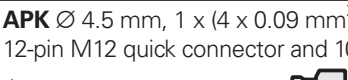
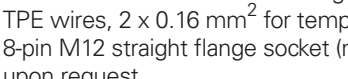
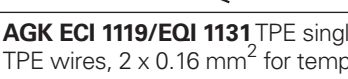
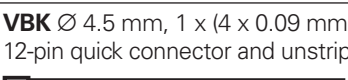





ID		Length	A <sub>p</sub>	Use with
1036775-xx	<b>APK</b> Ø 4.5 mm, 1 x (4 x 0.09 mm <sup>2</sup> ) + 4 x 0.16 mm <sup>2</sup> ; 14-pin M12 coupling and 10-pin Mini Delta Ribbon connector (female) 	1 m to 30 m	2 x 0.16 mm <sup>2</sup>	Mit...
1036781-xx	<b>APK</b> Ø 6 mm, 2 x (2 x 0.09 mm <sup>2</sup> ) + 2 x (2 x 0.16 mm <sup>2</sup> ); 14-pin M12 coupling and 10-pin Mini Delta Ribbon connector (female) 	1 m to 30 m	2 x 0.16 mm <sup>2</sup>	Mit...
1036785-xx	<b>APK</b> Ø 4.5 mm, 1 x (4 x 0.09 mm <sup>2</sup> ) + 4 x 0.16 mm <sup>2</sup> ; 14-pin M12 coupling and 15-pin D-sub connector (female) 	1 m to 30 m	2 x 0.16 mm <sup>2</sup>	EnDat22
1036814-xx	<b>APK</b> Ø 6 mm, 2 x (2 x 0.09 mm <sup>2</sup> ) + 2 x (2 x 0.16 mm <sup>2</sup> ); 14-pin M12 coupling and 15-pin D-sub connector (female) 	1 m to 30 m	2 x 0.16 mm <sup>2</sup>	EnDat22
1070793-xx	<b>APK</b> Ø 6 mm, 1 x (4 x 0.16 mm <sup>2</sup> ) + 4 x 0.34 mm <sup>2</sup> ; 8-pin M12 connector (female) and 9-pin D-sub connector (male); (TNC X13) 	1 m to 30 m	0.34 mm <sup>2</sup>	TS/TT
1070794-xx	<b>APK</b> Ø 6 mm, 1 x (4 x 0.16 mm <sup>2</sup> ) + 4 x 0.34 mm <sup>2</sup> ; 8-pin M12 connector (female) and 15-pin, 3-row D-sub connector (male) (PLB X113) 	1 m to 30 m	0.34 mm <sup>2</sup>	TS/TT
1070795-xx	<b>APK</b> Ø 6 mm, 1 x (4 x 0.16 mm <sup>2</sup> ) + 4 x 0.34 mm <sup>2</sup> ; 8-pin M12 connector (female) and 15-pin, 3-row D-sub connector (male) (PLB X112) 	1 m to 30 m	0.34 mm <sup>2</sup>	TS/TT
1072523-xx	<b>APK</b> Ø 6 mm, 6 x (2 x 0.19 mm <sup>2</sup> ); 12-pin quick connector and 17-pin M23 mounted coupling with flange (male) 	0.5 m to 3 m	2 x 0.19 mm <sup>2</sup>	EnDat02
1072652-02	<b>AGK ECI 119/ECI/EQI 11xx</b> , Ø 3.7 mm EPG (cable clamp mounted over crimp sleeve), 1 x (4 x 0.06 mm <sup>2</sup> ) + 4 x 0.06 mm <sup>2</sup> with TPE wires, 2 x 0.16 mm <sup>2</sup> for temperature sensor; 15-pin PCB connector and contact insert for 6-pin HMC 6 hybrid connecting element (male) 	0.2 m	0.06 mm <sup>2</sup>	EnDat22
1073372-xx	<b>VBK</b> Ø 8 mm, 4 x (2 x 0.16 mm <sup>2</sup> ) + 4 x 0.5 mm <sup>2</sup> ; 15-pin, 3-row D-sub connector without locking screw (female) and 15-pin, 3-row D-sub connector (male) 	0.5 m to 20 m	0.5 mm <sup>2</sup>	TS/TT
1080050-xx	<b>VBK</b> Ø 6 mm, 2 x (2 x 0.09 mm <sup>2</sup> ) + 2 x (2 x 0.16 mm <sup>2</sup> ); 12-pin quick connector and unstripped cable end 	1 m to 20 m	2 x 0.16 mm <sup>2</sup>	EnDat22 Fanuc... Mit... Pana...





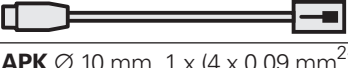

ID		Length	Ap	Use with
1080091-xx	<b>VBK</b> Ø 6 mm, 2 x (2 x 0.09 mm <sup>2</sup> ) + 2 x (2 x 0.16 mm <sup>2</sup> ); 15-pin D-sub connector without locking screws (female) and 15-pin D-sub connector (male); testing cable for PWM 21/PWT 100 	1 m to 15 m	2 x 0.16 mm <sup>2</sup>	EnDat21 EnDat22
1083190-xx	<b>VBK</b> Ø 10 mm, 1 x (4 x 0.16 mm <sup>2</sup> ) + 4 x 0.34 mm <sup>2</sup> ; partially covered with protective sleeve; 8-pin M12 connector (female) and unstripped cable end 	1 m to 50 m	0.34 mm <sup>2</sup>	TS/TT
1083369-xx	<b>APK</b> Ø 6 mm, 2 x (2 x 0.09 mm <sup>2</sup> ) + 2 x (2 x 0.16 mm <sup>2</sup> ); 14-pin M12 coupling and 25-pin D-sub connector (female) 	1 m to 30 m	2 x 0.16 mm <sup>2</sup>	EnDat22
1085542-xx	<b>VBK, suitable for vacuum;</b> 15-pin D-sub connector (female) and 15-pin D-sub connector (female) 	0.5 m to 10 m	2 x 0.05 mm <sup>2</sup>	1 V <sub>PP</sub>
1093042-xx	<b>APK</b> Ø 6.8 mm, green, 2 x (2 x 0.17 mm <sup>2</sup> ) + 1 x (2 x 0.24 mm <sup>2</sup> ); 8-pin M12 connector (female) and RJ45 connector 	1 m to 30 m	0.24 mm <sup>2</sup>	DQ...
1094652-xx	<b>APK</b> Ø 6.8 mm, green, 2 x (2 x 0.17 mm <sup>2</sup> ) + 1 x (2 x 0.24 mm <sup>2</sup> ); 8-pin M12 connector (female) and RJ45 IP67 connector 	1 m	0.24 mm <sup>2</sup>	DQ...
1095709-xx	<b>APK</b> Ø 4.5 mm; (Renishaw touch probe on the QUADRA-CHEK 3000); 5-pin DIN coupling (female) and 15-pin D-sub connector (male) 	0.5 m to 20 m	0.14 mm <sup>2</sup>	QUADRA-CHEK
1095953-xx	<b>APK</b> Ø 4.5 mm; (Renishaw touch probe on the ND 1xxx); 5-pin DIN coupling (female) and 15-pin D-sub connector (male) 	0.5 m to 20 m	0.14 mm <sup>2</sup>	ND
1099975-xx	<b>VBK</b> Ø 10 mm, 1 x (4 x 0.16 mm <sup>2</sup> ) + 4 x 0.34 mm <sup>2</sup> ; 8-pin M12 connector (female) and 7-pin M23 connector (male) 	1 m to 50 m	0.34 mm <sup>2</sup>	TS/TT
1100199-N3	<b>AGK ECN 1325/EQN 1337/ECI 1319/EQI 1331</b> TPE single wires with net sleeve (with shield crimping Ø 6.1 mm), 8 x 0.16 mm <sup>2</sup> ; 12-pin PCB connector and stripped cable end; collective package upon request 	0.3 m	2 x 0.16 mm <sup>2</sup>	EnDat22
1108076-01	<b>AGK ECN 1325/EQN 1337/ECI 1319/EQI 1331</b> Ø 3.7 mm EPG (with shield crimping Ø 6.1 mm), 1 x (4 x 0.06 mm <sup>2</sup> ) + 4 x 0.06 mm <sup>2</sup> and TPE wires 2 x 0.16 mm <sup>2</sup> for temperature sensor; 16-pin PCB connector and unstripped cable end; collective package upon request 	0.3 m	2 x 0.06 mm <sup>2</sup>	EnDat22







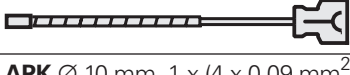
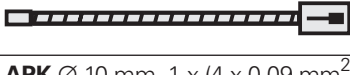
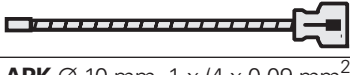
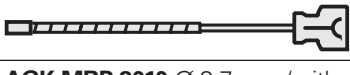
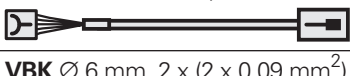



ID		Length	A <sub>P</sub>	Use with
1108078-01	<b>AGK ECN 1123/EQN 1135</b> Ø 3.7 mm EPG (with shield crimping Ø 4.3 mm), 1 x (4 x 0.06 mm <sup>2</sup> ) + 4 x 0.06 mm <sup>2</sup> and TPE wires, 2 x 0.16 mm <sup>2</sup> for temperature sensor; 15-pin PCB connector and unstripped cable end; collective package upon request 	0.3 m	2 x 0.06 mm <sup>2</sup>	EnDat22
1109993-xx	<b>VBK</b> Ø 10 mm, 6 x (2 x 0.19 mm <sup>2</sup> ); 12-pin M12 connector (female) and 12-pin M12 coupling (male) 	1 m to 20 m	0.19 mm <sup>2</sup>	TS/TT
1116479-03	<b>AGK ECI 119/EBI 135</b> Ø 3.7 mm EPG (cable clamp mounted over crimp sleeve), 1 x (4 x 0.06 mm <sup>2</sup> ) + 4 x 0.06 mm <sup>2</sup> and TPE wires, 2 x 0.16 mm <sup>2</sup> for temperature sensor; 15-pin PCB connector and unstripped cable end 	0.3 m	2 x 0.06 mm <sup>2</sup>	EnDat22
1117280-01	<b>AGK ECN 1325/EQN 1337/ECI 1319/EQI 1331</b> TPE single wires with net sleeve (with shield crimping Ø 6.1 mm), 8 x 0.16 mm <sup>2</sup> and TPE wires, 2 x 0.16 mm <sup>2</sup> for temperature sensor; 16-pin PCB connector and 8-pin M12 straight flange socket (male) without shield; collective package upon request 	0.3 m	2 x 0.16 mm <sup>2</sup>	EnDat22
1117412-01 1117412-03	<b>AGK ECN 1123/EQN 1135</b> TPE single wires with net sleeve (with shield crimping Ø 4.3 mm), 8 x 0.16 mm <sup>2</sup> and TPE wires, 2 x 0.16 mm <sup>2</sup> for temperature sensor; 15-pin PCB connector and 8-pin M12 straight flange socket (male) without shield; collective package upon request 	0.15 m 0.11 m	2 x 0.16 mm <sup>2</sup>	EnDat22
1117540-xx	<b>APK</b> Ø 6.8 mm, green, 2 x (2 x 0.17 mm <sup>2</sup> ) + 1 x (2 x 0.24 mm <sup>2</sup> ); 9-pin M23 connector (female) and RJ45 IP20 connector 	1 m to 30 m	0.24 mm <sup>2</sup>	DQ...
1118858-xx	<b>VBK</b> Ø 3.7 mm, 1 x (4 x 0.06 mm <sup>2</sup> ) + 4 x 0.06 mm <sup>2</sup> ; 8-pin M12 connector (female) and 8-pin M12 coupling (male) 	1 m to 6 m	2 x 0.06 mm <sup>2</sup>	EnDat22 Fanuc... Mit... Pana... YEC...
1118863-xx	<b>VBK</b> Ø 3.7 mm, 1 x (4 x 0.06 mm <sup>2</sup> ) + 4 x 0.06 mm <sup>2</sup> ; 8-pin M12 right-angle connector (female) and 8-pin M12 coupling (male) 	1 m to 6 m	2 x 0.06 mm <sup>2</sup>	EnDat22 Fanuc... Mit... Pana... YEC...
1118865-xx	<b>APK</b> Ø 3.7 mm, 1 x (4 x 0.06 mm <sup>2</sup> ) + 4 x 0.06 mm <sup>2</sup> ; 8-pin M12 connector (female) and 15-pin D-sub connector (male) 	1 m to 6 m	2 x 0.06 mm <sup>2</sup>	EnDat22 Fanuc... Mit... Pana... YEC...
1118867-xx	<b>APK</b> Ø 3.7 mm, 1 x (4 x 0.06 mm <sup>2</sup> ) + 4 x 0.06 mm <sup>2</sup> ; 8-pin M12 right-angle connector (female) and 15-pin D-sub connector (male) 	1 m to 6 m	2 x 0.06 mm <sup>2</sup>	EnDat22 Fanuc... Mit... Pana... YEC...











ID		Length	Ap	Use with
1118892-02	<b>AGK ERN 1387</b> PUR $\varnothing$ 4.5 mm, 16 x 0.057 mm <sup>2</sup> ; 14-pin PCB connector with strain relief and 15-pin D-sub connector (male), including three 14-pin adapter connectors; testing cable for PWM 21 	2 m	2 x 0.057 mm <sup>2</sup>	1 V <sub>PP</sub> + Z1
1119209-xx	<b>APK</b> $\varnothing$ 4.5 mm, 1 x (4 x 0.09 mm <sup>2</sup> ) + 4 x 0.16 mm <sup>2</sup> ; 12-pin M12 quick connector and 17-pin M23 coupling (male) 	0.5 m to 9 m	2 x 0.16 mm <sup>2</sup>	Fanuc... Mit...
1119352-xx	<b>APK</b> $\varnothing$ 4.5 mm, 1 x (4 x 0.09 mm <sup>2</sup> ) + 4 x 0.16 mm <sup>2</sup> ; 12-pin M12 connecting element and 15-pin D-sub connector (male) 	1 m to 30 m	2 x 0.16 mm <sup>2</sup>	EnDat22
1119394-xx	<b>APK</b> $\varnothing$ 4.5 mm, 1 x (4 x 0.09 mm <sup>2</sup> ) + 4 x 0.16 mm <sup>2</sup> ; 12-pin M12 quick connector and 15-pin D-sub connector (female) 	1 m to 30 m	2 x 0.16 mm <sup>2</sup>	EnDat22
1119910-xx	<b>APK</b> $\varnothing$ 4.5 mm, 1 x (4 x 0.09 mm <sup>2</sup> ) + 4 x 0.16 mm <sup>2</sup> ; 12-pin M12 quick connector and 25-pin D-sub connector (female) 	1 m to 30 m	2 x 0.16 mm <sup>2</sup>	EnDat22
1119918-xx	<b>APK</b> $\varnothing$ 4.5 mm, 1 x (4 x 0.09 mm <sup>2</sup> ) + 4 x 0.16 mm <sup>2</sup> ; 12-pin M12 quick connector and 15-pin Mini Delta Ribbon connector (female) 	1 m to 30 m	2 x 0.16 mm <sup>2</sup>	Fanuc...
1119920-xx	<b>APK</b> $\varnothing$ 4.5 mm, 1 x (4 x 0.09 mm <sup>2</sup> ) + 4 x 0.16 mm <sup>2</sup> ; 12-pin M12 quick connector and 20-pin Mini Delta Ribbon connector (male) 	1 m to 30 m	2 x 0.16 mm <sup>2</sup>	Mit...
1119925-xx	<b>APK</b> $\varnothing$ 4.5 mm, 1 x (4 x 0.09 mm <sup>2</sup> ) + 4 x 0.16 mm <sup>2</sup> ; 12-pin M12 quick connector and 10-pin Mini Delta Ribbon connector (female) 	1 m to 30 m	2 x 0.16 mm <sup>2</sup>	Mit...
1119952-15	<b>AGK ECI 1119/EQI 1131</b> TPE single wires with net sleeve, 8 x 0.16 mm <sup>2</sup> and TPE wires, 2 x 0.16 mm <sup>2</sup> for temperature sensor; 15-pin PCB connector and 8-pin M12 straight flange socket (male) without shield; collective package upon request 	0.15 m	2 x 0.16 mm <sup>2</sup>	EnDat22
1119958-15	<b>AGK ECI 1119/EQI 1131</b> TPE single wires with net sleeve, 8 x 0.16 mm <sup>2</sup> and TPE wires, 2 x 0.16 mm <sup>2</sup> for temperature sensor; 15-pin PCB connector and stripped cable end, without shield; collective package upon request 	0.15 m	2 x 0.16 mm <sup>2</sup>	EnDat22
1120664-xx	<b>VBK</b> $\varnothing$ 4.5 mm, 1 x (4 x 0.09 mm <sup>2</sup> ) + 4 x 0.16 mm <sup>2</sup> ; 12-pin quick connector and unstripped cable end 	1 m to 20 m	2 x 0.16 mm <sup>2</sup>	EnDat22 Fanuc... Mit... Pana... YEC...

















ID		Length	A <sub>p</sub>	Use with
1120686-xx	<b>APK</b> Ø 6 mm, 2 x (2 x 0.09 mm <sup>2</sup> ) + 2 x (2 x 0.16 mm <sup>2</sup> ); 15-pin D-sub connector (female) and 8-pin M12 coupling (male) 	1 m to 30 m	2 x 0.16 mm <sup>2</sup>	EnDat22 Fanuc... Mit... Pana... YEC...
1120940-30	<b>AGK ECI 4010/EBI 4010</b> Ø 3.7 mm EPG (with shield crimping Ø 4.3 mm), 1 x (4 x 0.06 mm <sup>2</sup> ) + 4 x 0.06 mm <sup>2</sup> and TPE wires, 2 x 0.16 mm <sup>2</sup> for temperature sensor; 15-pin PCB connector and 9-pin M23 SpeedTEC angle flange socket (male); collective package upon request 	0.3 m	2 x 0.06 mm <sup>2</sup>	EnDat22
1120945-15 1120945-30	<b>AGK ECN 1324S/EQN 1336S</b> Ø 3.7 mm EPG (with shield crimping Ø 6.1 mm), 2 x (2 x 0.06 mm <sup>2</sup> ) + 4 x 0.06 mm <sup>2</sup> and TPE wires, 2 x 0.16 mm <sup>2</sup> for temperature sensor; 16-pin PCB connector and 9-pin M23 SpeedTEC angle flange socket (male); collective package upon request 	0.15 m 0.3 m	2 x 0.06 mm <sup>2</sup>	DQ...
1120947-03	<b>AGK ECI 119/EBI 135</b> Ø 3.7 mm EPG (cable clamp mounted over crimp sleeve), 1 x (4 x 0.06 mm <sup>2</sup> ) + 4 x 0.06 mm <sup>2</sup> and TPE wires, 2 x 0.16 mm <sup>2</sup> for temperature sensor; 15-pin PCB connector and 9-pin M23 SpeedTEC angle flange socket (male) 	0.3 m	2 x 0.06 mm <sup>2</sup>	EnDat22
1120948-01	<b>AGK ECN 1325/EQN 1337/ECI 1319/EQI 1331</b> Ø 3.7 mm EPG (with shield crimping Ø 6.1 mm) 1 x (4 x 0.06 mm <sup>2</sup> ) + 4 x 0.06 mm <sup>2</sup> and TPE wires 2 x 0.16 mm <sup>2</sup> for temperature sensor; 16-pin PCB connector and 9-pin M23 SpeedTEC angle flange socket (male); collective package upon request 	0.3 m	2 x 0.06 mm <sup>2</sup>	EnDat22
1121041-03	<b>AGK ECI 4010/EBI 4010</b> Ø 3.7 mm EPG (with shield crimping Ø 4.3 mm), 1 x (4 x 0.06 mm <sup>2</sup> ) + 4 x 0.06 mm <sup>2</sup> ; 15-pin PCB connector and 9-pin M23 SpeedTEC angle flange socket (male); collective package upon request 	0.3 m	2 x 0.06 mm <sup>2</sup>	EnDat22
1121536-xx	<b>APK</b> Ø 6.8 mm, green, 2 x (2 x 0.17 mm <sup>2</sup> ) + 1 x (2 x 0.24 mm <sup>2</sup> ); 9-pin M23 SpeedTEC connector (female) and 8-pin M12 coupling (male) 	1 m to 30 m	0.24 mm <sup>2</sup>	DQ...
1121546-xx	<b>APK</b> Ø 6.8 mm, green, 2 x (2 x 0.17 mm <sup>2</sup> ) + 1 x (2 x 0.24 mm <sup>2</sup> ); 9-pin M23 SpeedTEC connector (female) and RJ45 IP20 connector 	1 m to 30 m	0.24 mm <sup>2</sup>	DQ...
1121591-xx	<b>APK PUR</b> Ø 6.8 mm, green, 2 x (2 x 0.17 mm <sup>2</sup> ) + 1 x (2 x 0.24 mm <sup>2</sup> ); 6-pin RJ45 IP67 connector (male) with metal housing and 8-pin M12 coupling (male) 	20 m	0.24 mm <sup>2</sup>	DQ...
1122879-xx	<b>APK</b> Ø 10 mm, 1 x (4 x 0.09 mm <sup>2</sup> ) + 4 x 0.16 mm <sup>2</sup> ; 14-pin M12 coupling and 8-pin M12 coupling (male) 	1 m to 20 m	2 x 0.16 mm <sup>2</sup>	EnDat22 Fanuc... Mit... Pana... YEC...

ID		Length	Ap	Use with
1123096-xx	<b>APK</b> Ø 10 mm, 1 x (4 x 0.09 mm <sup>2</sup> ) + 4 x 0.16 mm <sup>2</sup> ; 14-pin M12 coupling and 15-pin D-sub connector (male) 	1 m to 30 m	2 x 0.16 mm <sup>2</sup>	EnDat22 Pana...
1123108-xx	<b>APK</b> Ø 10 mm, 1 x (4 x 0.09 mm <sup>2</sup> ) + 4 x 0.16 mm <sup>2</sup> ; 14-pin M12 coupling and 15-pin D-sub connector (female) 	1 m to 30 m	2 x 0.16 mm <sup>2</sup>	EnDat22
1125403-N3	<b>AGK ECI 4090S</b> Ø 3.7 mm EPG (with shield crimping Ø 4.3 mm), 2 x (2 x 0.06 mm <sup>2</sup> ) + 4 x 0.06 mm <sup>2</sup> and TPE wires, 2 x 0.16 mm <sup>2</sup> for temperature sensor; 15-pin PCB connector and 9-pin M23 SpeedTEC angle flange socket (male); collective package upon request 	0.3 m	2 x 0.06 mm <sup>2</sup>	DQ...
1125408-N3	<b>AGK ECI 4090S</b> Ø 3.7 mm EPG (with shield crimping Ø 4.3 mm), 2 x (2 x 0.06 mm <sup>2</sup> ) + 4 x 0.06 mm <sup>2</sup> ; 15-pin PCB connector and 9-pin M23 SpeedTEC angle flange socket (male); collective package upon request 	0.3 m	2 x 0.06 mm <sup>2</sup>	DQ...
1126031-xx	<b>APK</b> Ø 10 mm, 1 x (4 x 0.09 mm <sup>2</sup> ) + 4 x 0.16 mm <sup>2</sup> ; 14-pin M12 coupling and 15-pin Mini Delta Ribbon connector (female) 	1 m to 30 m	2 x 0.16 mm <sup>2</sup>	Fanuc...
1126035-xx	<b>APK</b> Ø 10 mm, 1 x (4 x 0.09 mm <sup>2</sup> ) + 4 x 0.16 mm <sup>2</sup> ; 14-pin M12 coupling and 17-pin M23 coupling (male) 	1 m to 9 m	2 x 0.16 mm <sup>2</sup>	EnDat22 Fanuc... Mit... Pana...
1127794-xx	<b>APK</b> Ø 10 mm, 1 x (4 x 0.09 mm <sup>2</sup> ) + 4 x 0.16 mm <sup>2</sup> ; 14-pin M12 coupling and 20-pin Mini Delta Ribbon connector (male) 	1 m to 30 m	2 x 0.16 mm <sup>2</sup>	Mit...
1127827-xx	<b>APK</b> Ø 10 mm, 1 x (4 x 0.09 mm <sup>2</sup> ) + 4 x 0.16 mm <sup>2</sup> ; 14-pin M12 coupling and 10-pin Mini Delta Ribbon connector (female) 	1 m to 30 m	2 x 0.16 mm <sup>2</sup>	Mit...
1129083-xx	<b>AGK MRP 2010</b> Ø 3.7 mm (with shield crimping Ø 3.7 mm), 1 x (4 x 0.06 mm <sup>2</sup> ) + 4 x 0.06 mm <sup>2</sup> ; 12-pin PCB connector and 8-pin M12 coupling (male) 	0.3 m 6 m	2 x 0.06 mm <sup>2</sup>	EnDat22
1129581-xx	<b>VBK</b> Ø 6 mm, 2 x (2 x 0.09 mm <sup>2</sup> ) + 2 x (2 x 0.16 mm <sup>2</sup> ); 8-pin M12 connector (female) and unstripped cable end 	1 m to 30 m	2 x 0.16 mm <sup>2</sup>	EnDat22 Fanuc... Mit... Pana... YEC...
1129591-xx	<b>VBK</b> Ø 8 mm, 2 x (2 x 0.24 mm <sup>2</sup> ) + 2 x (2 x 0.35 mm <sup>2</sup> ); 8-pin M12 connector (female) and unstripped cable end 	1 m to 50 m	2 x 0.35 mm <sup>2</sup>	EnDat22 Fanuc... Mit... Pana... YEC...

ID		Length	A <sub>P</sub>	Use with
1129753-xx	<b>APK</b> Ø 8 mm, 2 x (2 x 0.24 mm <sup>2</sup> ) + 2 x (2 x 0.35 mm <sup>2</sup> ); 8-pin M12 connector (female) and 15-pin D-sub connector (male) 	1 m to 50 m	2 x 0.35 mm <sup>2</sup>	EnDat22 Fanuc... Mit... Pana... YEC...
1130829-xx	<b>APK</b> Ø 6 mm, 2 x (2 x 0.09 mm <sup>2</sup> ) + 2 x (2 x 0.16 mm <sup>2</sup> ); 8-pin M12 connector (female) and 17-pin M23 coupling (male) 	1 m to 9 m	2 x 0.16 mm <sup>2</sup>	EnDat22 Fanuc... Mit... Pana... YEC...
1130952-xx	<b>APK</b> Ø 6 mm, 2 x (2 x 0.09 mm <sup>2</sup> ) + 2 x (2 x 0.16 mm <sup>2</sup> ); 8-pin M12 connector (female) and 15-pin Mini Delta Ribbon connector (female) 	1 m to 30 m	2 x 0.16 mm <sup>2</sup>	Fanuc...
1130978-xx	<b>APK</b> Ø 8 mm, 2 x (2 x 0.24 mm <sup>2</sup> ) + 2 x (2 x 0.35 mm <sup>2</sup> ); 8-pin M12 connector (female) and 15-pin Mini Delta Ribbon connector (female) 	1 m to 50 m	2 x 0.35 mm <sup>2</sup>	Fanuc...
1130994-xx	<b>APK</b> Ø 8 mm, 2 x (2 x 0.24 mm <sup>2</sup> ) + 2 x (2 x 0.35 mm <sup>2</sup> ); 8-pin M12 connector (female) and 15-pin D-sub connector (female) 	1 m to 50 m	2 x 0.35 mm <sup>2</sup>	EnDat22
1132594-xx	<b>APK</b> Ø 6 mm, 2 x (2 x 0.09 mm <sup>2</sup> ) + 2 x (2 x 0.16 mm <sup>2</sup> ); 8-pin M12 connector (female) and 20-pin Mini Delta Ribbon connector (male) 	1 m to 30 m	2 x 0.16 mm <sup>2</sup>	Mit...
1132621-xx	<b>APK</b> Ø 6 mm, 2 x (2 x 0.09 mm <sup>2</sup> ) + 2 x (2 x 0.16 mm <sup>2</sup> ); 8-pin M12 connector (female) and 10-pin Mini Delta Ribbon connector (female) 	1 m to 30 m	2 x 0.16 mm <sup>2</sup>	Mit...
1133104-xx	<b>APK</b> Ø 6 mm, 2 x (2 x 0.09 mm <sup>2</sup> ) + 2 x (2 x 0.16 mm <sup>2</sup> ); 8-pin M12 connector (female) and 25-pin D-sub connector (female) 	1 m to 30 m	2 x 0.16 mm <sup>2</sup>	EnDat22
1133119-xx	<b>APK</b> Ø 8 mm, 2 x (2 x 0.24 mm <sup>2</sup> ) + 2 x (2 x 0.35 mm <sup>2</sup> ); 8-pin M12 connector (female) and 25-pin D-sub connector (female) 	1 m to 50 m	2 x 0.35 mm <sup>2</sup>	EnDat22
1133799-xx	<b>VBK</b> Ø 6 mm, 2 x (2 x 0.09 mm <sup>2</sup> ) + 2 x (2 x 0.16 mm <sup>2</sup> ); 8-pin M12 right-angle connector (female) and unstripped cable end 	1 m to 30 m	2 x 0.16 mm <sup>2</sup>	EnDat22 Fanuc... Mit... Pana... YEC...
1133832-xx	<b>VBK</b> Ø 8 mm, 2 x (2 x 0.24 mm <sup>2</sup> ) + 2 x (2 x 0.35 mm <sup>2</sup> ); 8-pin M12 right-angle connector (female) and unstripped cable end 	1 m to 50 m	2 x 0.35 mm <sup>2</sup>	EnDat22 Fanuc... Mit... Pana... YEC...

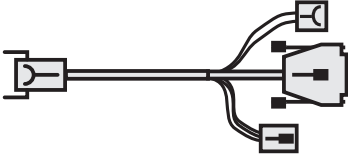
ID		Length	Ap	Use with
1133855-xx	<p><b>APK</b> Ø 6 mm, 2 x (2 x 0.09 mm<sup>2</sup>) + 2 x (2 x 0.16 mm<sup>2</sup>); 8-pin M12 right-angle connector (female) and 15-pin D-sub connector (male)</p> 	1 m to 10 m	2 x 0.16 mm <sup>2</sup>	EnDat22 Fanuc... Mit... Pana... YEC...
1136863-xx	<p><b>APK</b> Ø 6 mm, 2 x (2 x 0.09 mm<sup>2</sup>) + 2 x (2 x 0.16 mm<sup>2</sup>); 9-pin M23 connector (female) and 8-pin M12 coupling (male)</p> 	1 m to 9 m	2 x 0.16 mm <sup>2</sup>	EnDat22
1136874-xx	<p><b>APK</b> Ø 8 mm, 2 x (2 x 0.24 mm<sup>2</sup>) + 2 x (2 x 0.35 mm<sup>2</sup>); 9-pin M23 connector (female) and 8-pin M12 coupling (male)</p> 	1 m to 9 m	2 x 0.35 mm <sup>2</sup>	EnDat22
1137151-xx	<p><b>AGK MRP 5010/MRP 8010</b> Ø 3.7 mm (with shield crimping Ø 3.7 mm), 1 x (4 x 0.06 mm<sup>2</sup>) + 4 x 0.06 mm<sup>2</sup>; 15-pin PCB connector and 8-pin M12 coupling (male)</p> 	0.3 m 6 m	2 x 0.06 mm <sup>2</sup>	EnDat22
1139183-xx	<p><b>VBK PUR</b> Ø 6 mm, 2 x (2 x 0.09 mm<sup>2</sup>) + 2 x (2 x 0.16 mm<sup>2</sup>); 15-pin, 2-row D-sub connector (female) with locking screws and 15-pin D-sub connector (male)</p> 	1 m to 30 m	2 x 0.16 mm <sup>2</sup>	EnDat22
1143830-30	<p><b>AGK ECN 1325/EQN 1337/ECI 1319/EQI 1331</b>, TPE single wires with net sleeve, 8 x 0.16 mm<sup>2</sup> and TPE wires, 2 x 0.16 mm<sup>2</sup> for temperature sensor; 16-pin PCB connector and stripped cable end, without shield; collective package upon request</p> 	0.3 m	2 x 0.16 mm <sup>2</sup>	EnDat22
1156708-xx	<p><b>APK VS 101</b>, PUR Ø 6.8 mm, 4 x (2 x 0.17 mm<sup>2</sup>); 8-pin M12 connector (female) and 8-pin RJ45 connector</p> 	15 m 20 m	–	VS 101
1158342-xx	<p><b>APK</b> Ø 4.5 mm, 1 x (4 x 0.09 mm<sup>2</sup>) + 4 x 0.16 mm<sup>2</sup>; 14-pin M12 coupling and 15-pin D-sub connector (male)</p> 	1 m to 30 m	2 x 0.16 mm <sup>2</sup>	EnDat22 Pana...
1159446-xx	<p><b>APK</b> Ø 6 mm; encoder adapter cable for direct connection to AccurET position controllers; 15-pin, 2-row D-sub connector (female) and 15-pin, 3-row D-sub connector (male) with locking screws</p> 	1 m to 20 m	2 x 0.19 mm <sup>2</sup>	1 V <sub>PP</sub>
1160261-xx	<p><b>APK</b> Ø 6 mm, 2 x (2 x 0.09 mm<sup>2</sup>) + 2 x (2 x 0.16 mm<sup>2</sup>); 14-pin M12 coupling and 10-pin MUF connector (female)</p> 	1 m to 30 m	2 x 0.16 mm <sup>2</sup>	Pana...
1160268-xx	<p><b>APK</b> Ø 6 mm, 2 x (2 x 0.09 mm<sup>2</sup>) + 2 x (2 x 0.16 mm<sup>2</sup>); 8-pin M12 connector (female) and 10-pin MUF connector (female)</p> 	1 m to 30 m	2 x 0.16 mm <sup>2</sup>	Pana...

ID		Length	A <sub>P</sub>	Use with
1160480-xx	<b>AGK MRP 2080</b> Ø 3.7 mm (with shield crimping Ø 3.7 mm), 6 x (6 x 0.05 mm <sup>2</sup> ); 14-pin PCB connector and 15-pin D-sub connector (male) 	0.3 m 6 m	2 x 0.05 mm <sup>2</sup>	1 V <sub>PP</sub>
1160559-01	<b>AGK ECI 4090S</b> Ø 3.7 mm EPG (with shield crimping Ø 4.3 mm), 2 x (2 x 0.06 mm <sup>2</sup> ) + 4 x 0.06 mm <sup>2</sup> ; 15-pin PCB connector and 8-pin M12 coupling (male); collective package upon request 	1 m	2 x 0.06 mm <sup>2</sup>	DQ...
1165032-xx	<b>APK</b> Ø 6 mm; encoder adapter cable for direct connection to AccurET position controllers; 8-pin M12 connector (female) and 15-pin, 3-row D-sub connector (male) with clamping screws 	1 m to 20 m	2 x 0.14 mm <sup>2</sup>	EnDat22
1173166-xx	<b>APK PUR</b> Ø 6 mm, 2 x (2 x 0.09 mm <sup>2</sup> ) + 2 x (2 x 0.16 mm <sup>2</sup> ); 9-pin M23 connector (female) and 15-pin, 2-row D-sub connector (male) with locking screws 	9 m	2 x 0.16 mm <sup>2</sup>	EnDat22
1180354-03	<b>VBK</b> , spiral cable, 4 x 0.14; 8-pin M12 connector (female) and unstripped cable end 	3 m	0.14 mm <sup>2</sup>	TS/TT
1180955-xx	<b>AGK AEF 1323</b> Ø 4.5 mm PUR (with shield crimping Ø 6.1 mm), 3 x 2 x 0.19 mm <sup>2</sup> and TPE wires, 2 x 0.16 mm <sup>2</sup> for temperature sensor; 16-pin PCB connector and unstripped cable end 	6 m 10 m 15 m	2 x 0.19 mm <sup>2</sup>	EnDat22
1180959-xx	<b>AGK AEF 1323</b> Ø 4.5 mm PUR (with shield crimping Ø 6.1 mm), 3 x 2 x 0.19 mm <sup>2</sup> ; 12-pin PCB connector and unstripped cable end 	6 m 10 m 15 m	2 x 0.19 mm <sup>2</sup>	EnDat22
1181373-15 1181373-30	<b>AGK ECN 1324S/EQN 1336S</b> Ø 3.7 mm; EPG, (with shield crimping Ø 6.1 mm), 2 x (2 x 0.06 mm <sup>2</sup> ) + 4x 0.06 mm <sup>2</sup> and TPE wires, 2 x 0.16 mm <sup>2</sup> for temperature sensor; 16-pin PCB connector and 8-pin M12 flange socket (male); collective package upon request 	0.15 m 0.3 m	0.06 mm <sup>2</sup>	DQ...
1183206-xx	<b>VBK</b> Ø 6 mm, 6 x (2 x 0.19 mm <sup>2</sup> ); 15-pin, 3-row D-sub connector (female) and 15-pin, 3-row D-sub connector (male) 	1 m to 10 m	0.19 mm <sup>2</sup>	TS/TT
1188098-xx	<b>VBK PUR</b> Ø 13.6 mm, orange, (2 x (2 x 0.09 mm <sup>2</sup> ) + 2 x 0.24 mm <sup>2</sup> ) + (2 x 1.0 mm <sup>2</sup> + 1 x 1.5 mm <sup>2</sup> ) + (3 x 1.5 mm <sup>2</sup> ); 1.5 mm <sup>2</sup> power wires with M23 SpeedTEC hybrid connector for HMC 6, and unstripped cable end 	10 m 25 m 50 m	0.24 mm <sup>2</sup>	EnDat22
1188099-xx	<b>VBK PUR</b> Ø 16.6 mm, orange, (2 x (2 x 0.09 mm <sup>2</sup> ) + 2 x 0.24 mm <sup>2</sup> ) + (2 x 1.0 mm <sup>2</sup> + 1 x 4 mm <sup>2</sup> ) + (3 x 4 mm <sup>2</sup> ); 4 mm <sup>2</sup> power wires with M23 SpeedTEC hybrid connector for HMC 6, and unstripped cable end 	10 m 25 m 50 m	0.24 mm <sup>2</sup>	EnDat22

ID		Length	Ap	Use with
1189174-01	<p><b>APK</b> PUR Ø 13.6 mm, orange, (2 x (2 x 0.09 mm<sup>2</sup>) + 2 x 0.24 mm<sup>2</sup>) + (2 x 1.0 mm<sup>2</sup> + 1 x 1.5 mm<sup>2</sup>) + (3 x 1.5 mm<sup>2</sup>); 1.5 mm<sup>2</sup> power wires with M23 SpeedTEC hybrid connector for HMC 6 and 15-pin D-sub connector (male), testing cable for PWM 21</p> 	1 m	0.24 mm <sup>2</sup>	EnDat22
1217425-xx	<p><b>VBK</b> Ø 6 mm, 6 x (2 x 0.19 mm<sup>2</sup>); 15-pin, 3-row D-sub connector (female) and stripped cable end</p> 	1 m to 10 m	0.19 mm <sup>2</sup>	TS/TT
1228399-01	<p><b>APK</b> PUR Ø 6.8 mm, green, 2 x (2 x 0.17 mm<sup>2</sup>) + 1 x (2 x 0.24 mm<sup>2</sup>); 2-row D-sub connector (female) and RJ45 IP20 connector with metal housing</p> 	1 m	0.24 mm <sup>2</sup>	DQ...
1269882-xx	<p><b>APK</b> Ø 4.5 mm, 4 x (2 x 0.16 mm<sup>2</sup>); 8-pin M12 connector (female) and 6-pin Mini Delta Ribbon connector (female)</p> 	1 m to 6 m	2 x 0.16 mm <sup>2</sup>	YEC...

# Signal cables

Signal cables are available in predefined lengths for various interfaces. These lengths are tied to a certain variant. The type of packaging also depends on the length. In the *Pin layouts* chapter, you will find the wire color assignments.



ID	Cable type	Cable configuration	A <sub>P</sub>	Use with
816317-xx	PUR Ø 8 mm	4 x (2 x 0.14 mm <sup>2</sup> ) + 4 x 0.5 mm <sup>2</sup>	2 x 0.5 mm <sup>2</sup>	1 V <sub>PP</sub> TTL HTL
816322-xx	PUR Ø 8 mm	(4 x 0.14 mm <sup>2</sup> ) + 4 x (2 x 0.14 mm <sup>2</sup> ) + 4 x 0.5 mm <sup>2</sup>	2 x 0.5 mm <sup>2</sup>	EnDat01 EnDat02
816323-xx	PUR Ø 6 mm	6 x (2 x 0.19 mm <sup>2</sup> )	2 x 0.19 mm <sup>2</sup>	1 V <sub>PP</sub> TTL HTL
816327-xx	PUR Ø 8 mm	1 x (4 x 0.16 mm <sup>2</sup> ) + (4 x 1.0 mm <sup>2</sup> )	2 x 1.0 mm <sup>2</sup>	Fanuc... Mit...
1150200-xx	PUR Ø 6 mm	2 x (2 x 0.09 mm <sup>2</sup> ) + 2 x (2 x 0.16 mm <sup>2</sup> )	2 x 0.16 mm <sup>2</sup>	EnDat22 EnDat21 Fanuc... Mit... Pana... YEC...

Variant	Packaging	Length
-01	Bundle in bag	10 m
-02	Bundle in bag	20 m
-04	Bundle on cardboard core	100 m

# Connecting elements

## M8, M12, and M23 connecting elements

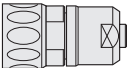
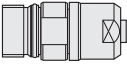
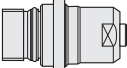
Loose connecting elements in solder and crimp versions (if needed) are available for the following connecting element types: M8, M12, and M23. Models in D-sub, MIL, and HMC 6 versions are also available as special accessories.

Model	Number of poles	Type	Contact	Type of contact	
<b>M12</b> 	8-pin	Connector	Female	Solder	
		Coupling	Male	Solder	
	8-pin	Adapter connector	Wall duct 1:1		
<b>M23</b> <b>Connector</b>  <b>Coupling</b>  <b>Mounted coupling with flange</b>  <b>Mounted coupling with central fastening</b>  <b>Flange socket</b> 	7-pin	Connector	Male	Solder	
		Coupling	Female	Solder	
		9-pin	Connector	Male	Solder
			Coupling	Female	Solder
			Mounted coupling with flange	Male	Solder
				Female	Solder
	Flange socket			Male	Solder
	12-pin		Connector	Male	Solder
		Female		Solder	
		Crimp			
		Mounted connector	Female	Solder	
		Coupling	Male	Solder	
			Female	Solder	
		Mounted coupling with flange	Male	Solder	
			Male	Crimp	
			Female	Solder	
		Mounted coupling with central fastening	Male	Solder	
		Flange socket	Male	Solder	
			Female	Solder	
			Adapter connector	Connector (female) and connector (male)	
		17-pin	Connector	Male	Crimp
				Female	Crimp
	Mounted connector		Female	Crimp	
	Coupling		Male	Crimp	
			Crimp (1 mm <sup>2</sup> )		
	Mounted coupling with flange		Male	Crimp	
			Female	Crimp	
Mounted coupling with central fastening	Male		Crimp		
Flange socket	Male		Crimp		
	Female		Crimp		
Assembly tool					
21-pin	Connector	Male	Crimp		
		Female	Crimp		
	Coupling	Male	Crimp		
	Flange socket	Male	Crimp		
		Female	Crimp		



ID for listed cable diameters					
xx	3.7 mm	4.5 mm (*3.5 mm to 5 mm)	6.00 mm	8.00 mm	(A) = 4.5 to 8.5 mm (B) = 6 to 10 mm
		582180-01			
		582180-02			
1142270-01					
			291697-14	291697-15	
				291697-13	
			291698-09		
		291697-02	291697-03	291697-04	
			291697-16	291697-01	
			291698-42	291698-24	
			291698-11	291698-01	
			291698-16		
			291698-15	291698-06	
315892-05					
315892-06					
		291697-06	291697-07	291697-08	
	291697-46	291697-47	291697-48	291697-49	
			291697-17	291697-05	
			291697-42		
	291698-38	291698-14	291698-03	291698-04	
			291698-12	291698-02	
		291698-23	291698-08	291698-31	
	291698-52	291698-53	291698-54	291698-55	
			291698-17	291698-07	
					741045-04 (A) 741045-01 (B)
315892-07					
315892-08					
373848-01					
				291697-27	
				291697-26	
			291697-36	291697-40	
		291698-49	291698-50	291698-27	
		291698-25	291698-26		
		291698-43	291698-41	291698-29	
				291698-35	
					741045-05 (A) 741045-02 (B)
315892-09					
315892-10					
236148-02					
				291697-31	
				291697-30	
				291698-30	
315892-11					
315892-12					

# D-sub, HMC 6 connecting elements

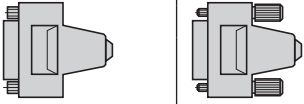
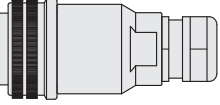
Model	Number of poles	Type	Contact	Type of contact
	15-pin	Connector	Female	Solder
	9-pin	Connector for external inputs on the IK 220	Female	Solder
	15-pin	Connector	Female	Solder
	25-pin	Connector for ND 200 switching inputs/ outputs	Male	Solder
			Female	Solder
<b>Circular connector</b> 	17-pin	Connector	Female	Solder

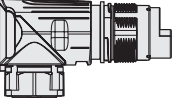
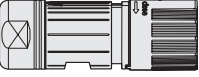
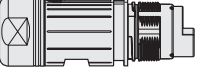
Model	Number of poles	Type	Contact	Type of contact
<b>M23 Flange socket SpeedTec</b> 	7-pin	<i>Service pack</i> Flange socket for HMC 6 Flange with bolt circle Ø 28 mm incl. contacts, contact insert, and dust protection cap <b>Without</b> communication element (see AGK) 2.5 mm <sup>2</sup> power wires	Male	Crimp
		<i>Service pack</i> Flange socket for HMC 6 Flange with bolt circle Ø 32 mm incl. contacts, contact insert, and dust protection cap <b>Without</b> communication element (see AGK) 2.5 mm <sup>2</sup> power wires	Male	Crimp
<b>Connector SpeedTec</b> 	7-pin + 6-pin	<i>Service pack</i> Connector for HMC 6 incl. contacts, contact insert, and communication element 1.5 mm <sup>2</sup> power wires	Female	Crimp
		<i>Service pack</i> Connector for HMC 6 incl. contacts, contact insert, and communication element 4.0 mm <sup>2</sup> power wires	Female	Crimp
<b>Coupling SpeedTec</b> 	7-pin + 6-pin	<i>Service pack</i> Coupling for HMC 6 incl. contacts, contact insert, and communication element 1.5 mm <sup>2</sup> power wires	Male	Crimp
		<i>Service pack</i> Coupling for HMC 6 incl. contacts, contact insert, and communication element 4.0 mm <sup>2</sup> power wires	Male	Crimp

Only for samples and servicing-related deliveries.

For larger purchase quantities, please refer to the stated supplier in the *HMC 6* Product Information document.







SpeedTEC is a registered trademark of TE Connectivity Industrial GmbH.

ID for listed cable diameters					
xx	3.7 mm	4.5 mm (*3.5 mm to 5 mm)	6.00 mm	8.00 mm	(A) = 4.5 to 8.5 mm (B) = 6 to 10 mm
315650-14					
315650-02					
315650-04					
315650-05					
315650-06					
				1094831-01	

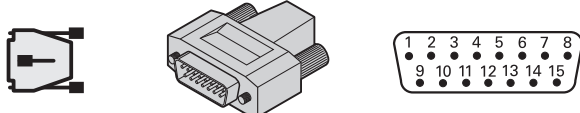
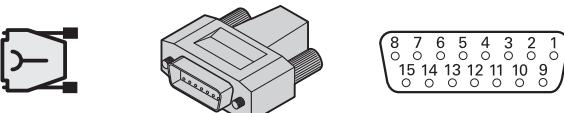
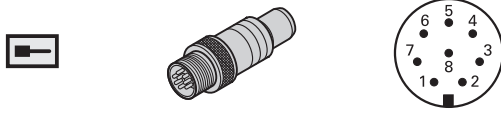
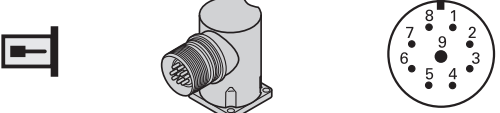
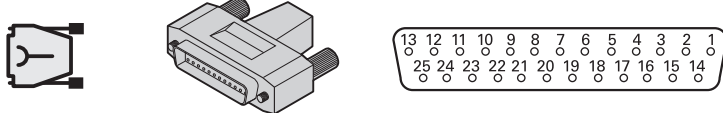
ID for listed cable diameters			
xx		13.6 mm Cable clamping range: Ø 9.5 mm to 14.5 mm	16.6 mm Cable clamping range: Ø 14 mm to 17 mm
1043027-01			
1043027-02			
		1075255-01	
			1075255-02
		1084549-01	
			1084549-02

# Pin layouts

## EnDat22

<p>① 15-pin D-sub connector</p> 	<p>② 15-pin D-sub connector</p> 							
<p>③ 8-pin M12 coupling</p> 	<p>④ 9-pin M23 flange socket</p> 							
<p>⑤ 25-pin D-sub connector</p> 								
	Power supply				Serial data			
①	4	12	2	10	5	13	8	15
②	1	9	2	11	5	8	14	15
③	8	2	5	1	3	4	7	6
④	3	7	4	8	5	6	1	2
⑤	1	14	2	16	15	23	10	12
	Brown/Green	Blue	White/Green	White	Gray	Pink	Violet	Yellow
	<b>U<sub>P</sub></b> 	<b>Sensor</b> <b>U<sub>P</sub></b> 	<b>0V</b> 	<b>Sensor</b> <b>0V</b> 	<b>DATA</b>	<b>DATA</b>	<b>CLOCK</b>	<b>CLOCK</b>

**Cable shield** connected to housing; **U<sub>P</sub>** = Supply voltage

**Sensor:** The sense line is connected in the encoder with the corresponding power line.

Vacant pins or wires must not be used!

### ① 15-pin

ND 280  
ND 287  
EIB 74x  
PWM 21  
PWT 100

### ② 15-pin

TNC  
(SMC 40)

### ③ 8-pin

M12









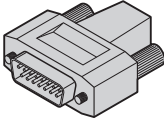
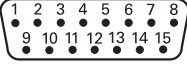

### ④ 9-pin

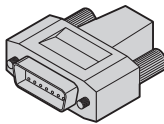
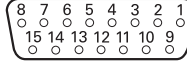
M23

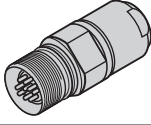
### ⑤ 25-pin

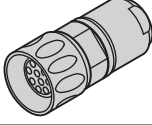
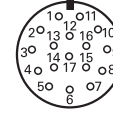
TNC

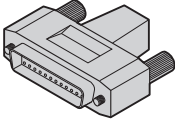
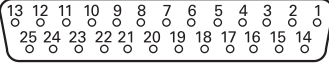
# EnDat 2.1 (EnDat01/EnDat02)

<b>① 15-pin D-sub connector</b>   					<b>② 15-pin D-sub connector</b>   										
<b>③ 17-pin M23 coupling</b>   					<b>③ 17-pin M23 connector</b>   										
<b>④ 25-pin D-sub connector</b>   															
	Power supply					Incremental signals				Serial data					
①	4	12	2	10	6	1	9	3	11	5	13	8	15	/	/
②	1	9	2	11	13	3	4	6	7	5	8	14	15	/	/
③	7	1	10	4	11 <sup>1)</sup>	15	16	12	13	14	17	8	9	5 <sup>3)</sup>	6 <sup>3)</sup>
④	1	14	2	16	/	3	4	6	7	15	23	10	12	13 <sup>4)</sup>	25 <sup>4)</sup>
	Brown/ Green	Blue	White/ Green	White	/	Green/ Black	Yellow/ Black	Blue/ Black	Red/ Black	Gray	Pink	Violet	Yellow	Green	Brown
	<b>U<sub>P</sub></b>	<b>Sensor</b> U <sub>P</sub>	<b>0V</b>	<b>Sensor</b> 0V	Internal shield	<b>A+</b>	<b>A-</b>	<b>B+</b>	<b>B-</b>	<b>DATA</b>	<b>DATA</b>	<b>CLOCK</b>	<b>CLOCK</b>	<b>T+</b>	<b>T-</b>

**Cable shield** connected to housing; **U<sub>P</sub>** = Supply voltage

**Sensor:** The sense line is connected in the encoder with the corresponding power line.

Vacant pins or wires must not be used!

<sup>1)</sup> Only ID 309778-xx, ID 323897-xx, ID 324544-xx, ID 332115-xx, ID 509667-xx

<sup>2)</sup> Motors from HEIDENHAIN have a different pin layout for the connection to the TNC.

For suitable cables, see the *Cable overview* in the TNC brochure *Information for the Machine Tool Builder*.

<sup>3)</sup> Only ID 309778-xx, ID 323897-xx, ID 332201-01, ID 509667-xx (deviating colors), ID 606079-01

<sup>4)</sup> Only ID 509667-xx (deviating colors)

## ① 15-pin

ND 280  
ND 287  
EIB 74x  
PWM 21  
PWT 100

## ② 15-pin

TNC  
IK 220



## ③ 17-pin



M23

## ④ 25-pin

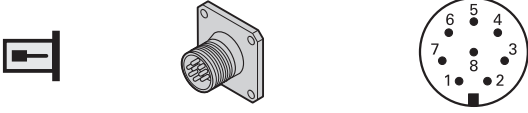
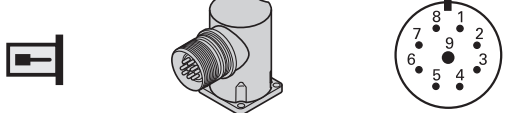
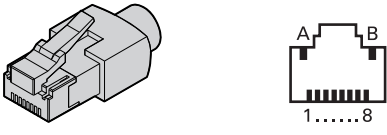
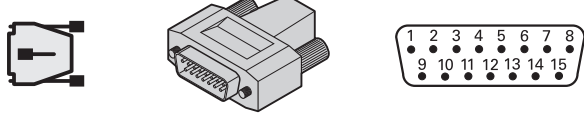
TNC  
(SMC 20)

# Siemens DRIVE-CLiQ

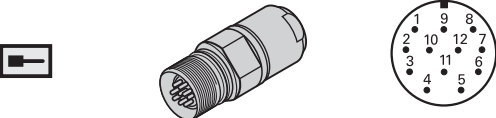
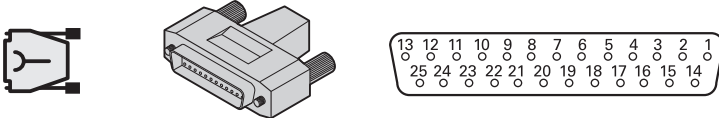
<b>① 8-pin M12 flange socket</b> 			<b>② 9-pin M23 flange socket</b> 			
<b>③ RJ45</b> 			<b>④ 15-pin D-sub connector</b> 			
	Power supply			Serial data		
①	1	5	3	4	7	6
②	8	4	5	6	1	2
③	A	B	3	6	1	2
④	10	2	8	15	5	13
	Red	Black	Green	Yellow	Pink	Blue
	<b>U<sub>P</sub></b>	<b>0V</b>	<b>RXP</b>	<b>RXN</b>	<b>TXP</b>	<b>TXN</b>





<b>⑤ 12-pin M23 coupling</b> 					<b>⑥ 25-pin D-sub connector</b> 								
	Power supply				Incremental signals						Other signals		
⑤	12	2	10	11	5	6	8	1	3	4	9	7	/
⑥	1	14	2	16	3	4	6	7	17	18	/	/	/
	Brown/ Green	Blue	White/ Green	White	Brown	Green	Gray	Pink	Red	Black	/	Violet	Yellow
	<b>U<sub>P</sub></b>	<b>Sensor</b> U <sub>P</sub>	<b>0V</b>	<b>Sensor</b> 0V	<b>A+</b>	<b>A-</b>	<b>B+</b>	<b>B-</b>	<b>R+</b>	<b>R-</b>	Vacant	Vacant	Vacant

**Cable shield** connected to housing; **U<sub>P</sub>** = Supply voltage

**Sensor:** The sense line is connected in the encoder with the corresponding power line.

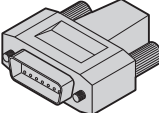
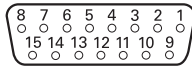
Vacant pins or wires must not be used!

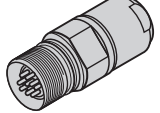
<b>① 8-pin</b> M12	<b>② 9-pin</b> M23	<b>③ RJ45</b> IP20 IP67	<b>④ 15-pin</b>	<b>⑤ 12-pin</b> SME 20 SME 120	<b>⑥ 25-pin</b> TNC (SMC 20)
-----------------------	-----------------------	-------------------------------	-----------------	--------------------------------------	------------------------------------



⑦ 15-pin D-sub connector					⑧ 17-pin M23 coupling								
													
	Power supply					Incremental signals				Serial data			
⑦	1	9	2	11	13	3	4	6	7	5	8	14	15
⑧	7	1	10	4	11	15	16	12	13	14	17	8	9
	Brown/ Green	Blue	White/ Green	White	/	Green/ Black	Yellow/ Black	Blue/ Black	Red/ Black	Gray	Pink	Violet	Yellow
	<b>U<sub>P</sub></b>	<b>Sensor</b> U <sub>P</sub>	<b>0V</b>	<b>Sensor</b> 0V	Internal shield	<b>A+</b>	<b>A-</b>	<b>B+</b>	<b>B-</b>	<b>DATA</b>	<b>DATA</b>	<b>CLOCK</b>	<b>CLOCK</b>

**Cable shield** connected to housing; **U<sub>P</sub>** = Supply voltage

**Sensor:** The sense line is connected in the encoder with the corresponding power line.

Vacant pins or wires must not be used!

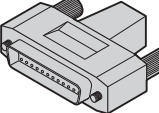
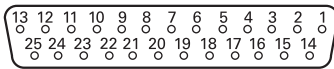
## Special cables

⑥ 25-pin D-sub connector															
															
	Power supply					Incremental signals				Serial data					
⑥	1	14	2	16	3	4	6	7	15	23	10	12	13 <sup>1)</sup>	25 <sup>1)</sup>	
	Brown/ Green	Blue	White/ Green	White	Green/ Black	Yellow/ Black	Blue/ Black	Red/ Black	Red	Black	Green	Brown	Yellow	Violet	
	<b>U<sub>P</sub></b>	<b>Sensor</b> U <sub>P</sub>	<b>0V</b>	<b>Sensor</b> 0V	<b>A+</b>	<b>A-</b>	<b>B+</b>	<b>B-</b>	<b>DATA</b>	<b>DATA</b>	<b>CLOCK</b>	<b>CLOCK</b>	<b>T+</b>	<b>T-</b>	

**Cable shield** connected to housing; **U<sub>P</sub>** = Supply voltage

**Sensor:** The sense line is connected in the encoder with the corresponding power line.

Vacant pins or wires must not be used!

<sup>1)</sup> Only ID 509667-xx





### ⑦ 15-pin

SMC 40

### ⑧ 17-pin

SME 25  
SME 125

# Fanuc purely serial

	Power supply					Serial data			
①	9	18/20	12	14	16	1	2	5	6
②	7	1	10	4	Housing	14	17	8	9
③	8	2	5	1	Housing	3	4	7	6
④	4	12	2	10	Housing	5	13	8	15
	Brown/Green	Blue	White/Green	White	/	Gray	Pink	Violet	Yellow
	<b>Up</b> 	<b>Sensor</b> Up 	<b>0V</b> 	<b>Sensor</b> 0V 	Shield	<b>Serial Data</b>	<b>Serial Data</b>	<b>Request</b>	<b>Request</b>

**Up** = Power supply

**Sensor:** The sense line is connected in the encoder with the corresponding power line.

Vacant pins or wires must not be used!

For the shield connection of the Fanuc connector, see also *General electrical information* in the *Interfaces of HEIDENHAIN Encoders* brochure.

## ① 15-pin

Fanuc α  
Fanuc αi

## ② 17-pin

M23



## ③ 8-pin

M12

## ④ 15-pin

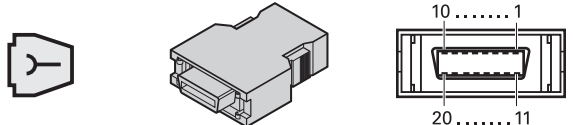
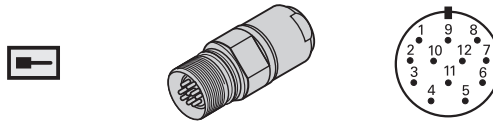
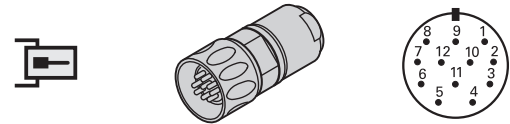

# Fanuc TTL

<b>⑤ 15-pin Fanuc connector</b> 													
<b>⑥ 12-pin M23 coupling</b> 						<b>⑥ 12-pin M23 connector</b> 							
	Power supply				Incremental signals						Other signals		
⑤	9	18+20	12	14	1	2	3	4	5	6	8	7	16
⑥	12	2	10	11	5	6	8	1	3	4	7	9	Housing
	Brown/ Green	Blue	White/ Green	White	Brown	Green	Gray	Pink	Red	Black	Violet	Yellow	/
	$U_P$	Sensor $U_P$	0V	Sensor 0V	$U_{a1}$	$\overline{U}_{a1}$	$U_{a2}$	$\overline{U}_{a2}$	$U_{a0}$	$\overline{U}_{a0}$	Only 2: $\overline{U}_{aS}$	Only 2: PWT test pulse	Shield



$U_P$  = Power supply

**Sensor:** The sense line is connected in the encoder with the corresponding power line.  
Vacant pins or wires must not be used!

⑤ 15-pin  
Fanuc TTL

⑥ 12-pin  
M23

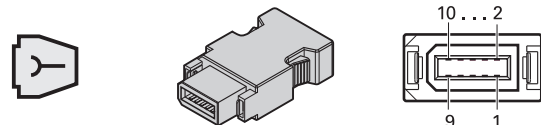
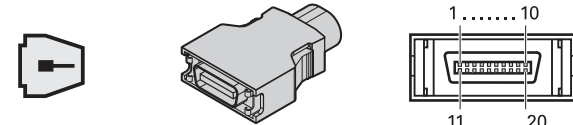
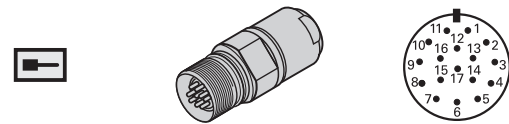
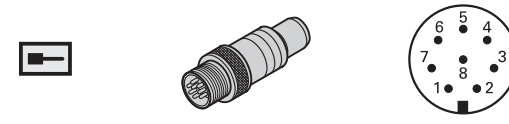
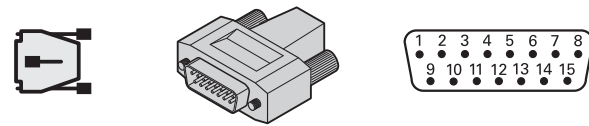
# Mitsubishi

<p>① 10-pin Mitsubishi connector</p> 	<p>② 20-pin Mitsubishi connector</p> 							
<p>③ 17-pin M23 coupling</p> 	<p>④ 8-pin M12 coupling</p> 							
<p>⑤ 15-pin D-sub connector</p> 								
	Power supply				Serial data			
①	1	/	2	/	7	8	3	4
②	20	19	1	11	6	16	7	17
③	7	1	10	4	14	17	8	9
④	8	2	5	1	3	4	7	6
⑤	4	12	2	10	5	13	8	15
	Brown/Green	Blue	White/Green	White	Gray	Pink	Violet	Yellow
Mit03-4	<b>U<sub>P</sub></b>	<b>Sensor</b> U <sub>P</sub>	<b>0V</b>	<b>Sensor</b> 0V	<b>Serial Data</b>	<b>Serial Data</b>	<b>Request Frame</b>	<b>Request Frame</b>
Mit02-2	<b>U<sub>P</sub></b>	<b>Sensor</b> U <sub>P</sub>	<b>0V</b>	<b>Sensor</b> 0V	Vacant	Vacant	<b>Request/ Data</b>	<b>Request/ Data</b>

**Cable shield** connected to housing; **U<sub>P</sub>** = Supply voltage

**Sensor:** The sense line is connected in the encoder with the corresponding power line.

Vacant pins or wires must not be used!

① 10-pin

Mitsubishi

② 20-pin

Mitsubishi

③ 17-pin





M23

④ 8-pin

M12

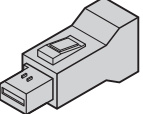
⑤ 15-pin

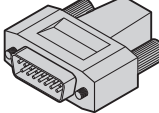
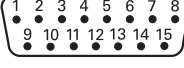
# Panasonic

① 10-pin Panasonic connector					② 8-pin M12 coupling				
									
③ 15-pin D-sub connector									
									
	Power supply				Serial data				
①	1	1	2	2	/	/	3	4	
②	8	2	5	1	3	4	7	6	
③	4	12	2	10	5	13	8	15	
	Brown/Green	Blue	White/Green	White	Gray	Pink	Violet	Yellow	
	<b>U<sub>P</sub></b>	<b>Sensor</b> U <sub>P</sub>	<b>0V</b>	<b>Sensor</b> 0V	Reserved, do not assign	Reserved, do not assign	<b>Request/ Data</b>	<b>Request/ Data</b>	

**Cable shield** connected to housing; **U<sub>P</sub>** = Supply voltage

**Sensor:** The sense line is connected in the encoder with the corresponding power line.

Vacant pins or wires must not be used!

## ① 10-pin



Panasonic

## ② 8-pin

M12

## ③ 15-pin

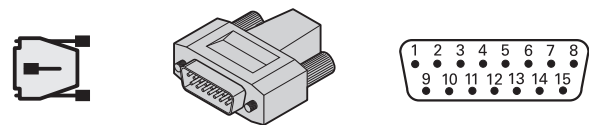
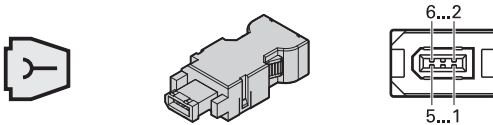
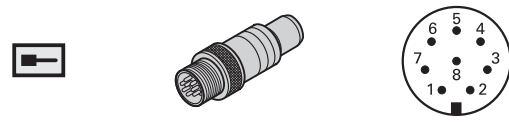
ND 280  
ND 287  
EIB 74x  
PWM 21  
PWT 100

<b>① 15-pin D-sub connector</b> 					<b>② 6-pin Yaskawa connector</b> 			
<b>③ 8-pin M12 coupling</b> 								
	Power supply				Serial data			
①	4	12	2	10	/	/	8	15
②	1	1	2	2	/	/	5	6
③	8	2	5	1	/	/	7	6
	Brown/Green	Blue	White/Green	White	Gray	Pink	Violet	Yellow
	<b>U<sub>P</sub></b>	<b>Sensor</b> U <sub>P</sub>	<b>0V</b>	<b>Sensor</b> 0V	Reserved, do not assign	Reserved, do not assign	<b>DATA</b>	<b>DATA</b>

**Cable shield** connected to housing; **U<sub>P</sub>** = Supply voltage

**Sensor:** The sense line is connected in the encoder with the corresponding power line.

Vacant pins or wires must not be used!

① 15-pin

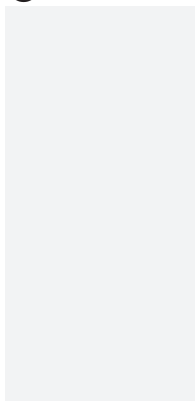



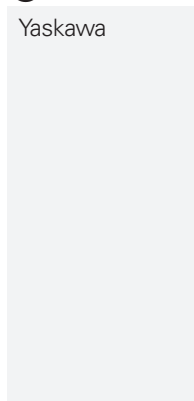



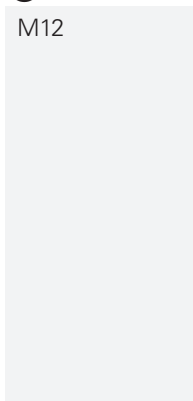

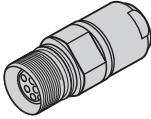

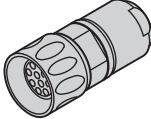
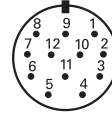
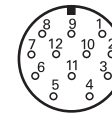
② 6-pin

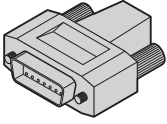
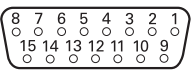

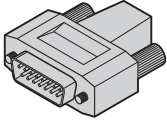
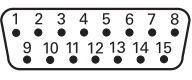
③ 8-pin

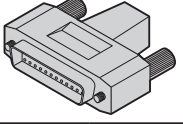
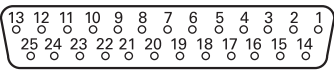

<b>① 12-pin M23 coupling</b>   					<b>① 12-pin M23 connector</b>   								
<b>② 15-pin D-sub connector</b>   					<b>③ 15-pin D-sub connector</b>   								
<b>④ 25-pin D-sub connector</b>   													
	Power supply				Incremental signals						Other signals		
①	12	2	10	11	5	6	8	1	3	4	9	7	/
②	1	9	2	11	3	4	6	7	10	12	5/8/13	14	15 <sup>1)</sup>
③	4	12	2	10	1	9	3	11	14	7	5/6/8	13	15 <sup>2)</sup>
④	1	14	2	16	3	4	6	7	17	18	5/8-13/ 15/19-25	/	/
	Brown/ Green	Blue	White/ Green	White	Brown	Green	Gray	Pink	Red	Black	/	Violet	Yellow
	<b>Up</b>	<b>Sensor</b> U <sub>P</sub>	<b>0V</b>	<b>Sensor</b> 0V	<b>A+</b>	<b>A-</b>	<b>B+</b>	<b>B-</b>	<b>R+</b>	<b>R-</b>	Vacant	Vacant	Vacant

**Shield** connected with housing; **Up** = Power supply

**Sensor:** The sense line is connected in the encoder with the corresponding power line.

Vacant pins or wires must not be used!

<sup>1)</sup> Only ID 349687-xx, ID 360974-xx, ID 335077-xx: reserved, do not use

<sup>2)</sup> Unstripped cable end with ID 310196-xx

## ① 12-pin

M23  
(SME 20)  
(SME 120)

## ② 15-pin

TNC  
IK 220







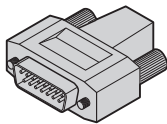
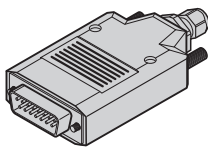
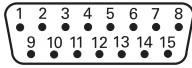

## ③ 15-pin

ND 280  
ND 287  
ND 11xx  
ND 13xx  
ND 14xx  
ND 21xx  
IK 5xxx  
EIB 74x  
PWM 21  
PWT 100  
QC 3000  
ND 7013  
ND 7013 I/O

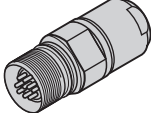
## ④ 25-pin

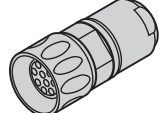
TNC  
(SMC 20)

## Special cables

③ 15-pin D-sub connector												
												
⑤ 17-pin M23 coupling					17-pin M23 connector							
												
	Power supply				Incremental signals							
③	4	12	2	10	1	9	3	11	14	7		
⑤ <sup>3)</sup>	7	1	10	4	15	16	12	13	3	2		
	Brown/ Green	Blue	White/ Green	White	Brown	Green	Gray	Pink	Red	Black		
	<b>Up</b>	<b>Sensor</b> Up	<b>0V</b>	<b>Sensor</b> 0V	<b>A+</b>	<b>A-</b>	<b>B+</b>	<b>B-</b>	<b>R+</b>	<b>R-</b>		
												
	Other signals											
③	13 <sup>2)</sup>	8 <sup>1)</sup>	6 <sup>1)</sup>	15 <sup>2)</sup>	5 <sup>2)</sup>	6	/	/	/	/	/	
⑤ <sup>3)</sup>	/	/	/	/	/	/	14	17	9	8	5	6
	Violet	Green/ Black	Yellow/ Black	Yellow	Red/Black	Yellow/ Black	/	/	/	/	/	
	<b>Vacant</b>	<b>H</b>	<b>L</b>	<b>Vacant</b>	<b>Vacant</b>	<b>Vacant</b>	<b>C+</b>	<b>C-</b>	<b>D+</b>	<b>D-</b>	<b>T+</b>	<b>T-</b>
	<b>DATA</b>	Vacant	Vacant	<b>CLOCK</b>	<b>Test</b>	Vacant						

**Shield** connected with housing; **Up** = Power supply

**Sensor:** The sense line is connected in the encoder with the corresponding power line.

Vacant pins or wires must not be used!

<sup>1)</sup> Only ID 354379-xx, ID 354411-xx, ID 355397-xx, ID 355398-xx

<sup>2)</sup> Only ID 735541-xx: with programming line for mounting the LIP 281





<sup>3)</sup> Only ID 323897-xx, deviating colors

**Note:** The listed devices can be connected. For information on additional data, please refer to the Product Information document of the device.

### ③ 15-pin

ND 280  
 ND 287  
 ND 13xx  
 ND 14xx  
 ND 21xx  
 IK 5xxx  
 EIB 74x  
 PWM 21  
 PWT 100  
 QC 2000  
 QC 3000  
 ND 7013  
 ND 7013 I/O

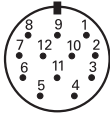
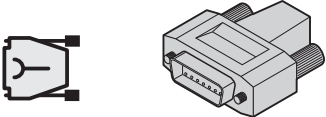
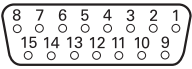
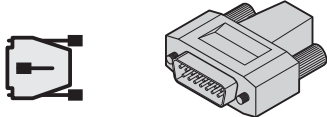
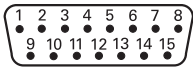
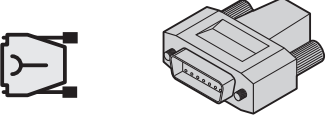
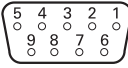
# TTL or HTL

<b>① 12-pin M23 coupling</b>  					<b>① 12-pin M23 connector</b>  								
<b>② 15-pin D-sub connector</b>  					<b>③ 15-pin D-sub connector</b>  								
<b>④ 9-pin D-sub connector</b>  													
	Power supply				Incremental signals						Other signals		
①	12	2	10	11	5	6	8	1	3	4	7	/	9 <sup>2)</sup>
②	1	9	2	11	3	4	6	7	10	12	14	5/8/13	15 <sup>2)</sup>
③	4	12	2	10	1	9	3	11	14	7	13	5/6/8	15 <sup>2)</sup>
④	7	7 <sup>3)</sup>	6	6 <sup>3)</sup>	2	3	4	5	9	8	/	/	/
	Brown/ Green	Blue	White/ Green	White	Brown	Green	Gray	Pink	Red	Black	Violet	/	Yellow
	<b>U<sub>P</sub></b>	<b>Sensor</b> U <sub>P</sub>	<b>0V</b>	<b>Sensor</b> 0V	<b>U<sub>a1</sub></b>	<b>U<sub>a1</sub></b>	<b>U<sub>a2</sub></b>	<b>U<sub>a2</sub></b>	<b>U<sub>a0</sub></b>	<b>U<sub>a0</sub></b>	<b>U<sub>aS</sub></b>	Vacant	Reserved, do not assign <sup>1)</sup>

**Cable shield** connected to housing; **U<sub>P</sub>** = Supply voltage

**Sensor:** The sense line is connected in the encoder with the corresponding power line.

Vacant pins or wires must not be used!

<sup>1)</sup> **Exposed linear encoders:** Conversion from TTL to 11 μA<sub>PP</sub> for the PWT; otherwise not assigned

<sup>2)</sup> Unstripped cable end with the following: ID 298429-xx, ID 309783-xx, ID 309784-xx, ID 310196-xx, ID 310199-xx

<sup>3)</sup> Only ID 617513-xx, ID 626015-xx; not with ID 617484-xx, ID 735210-xx

## ① 12-pin

M23

## ② 15-pin

## ③ 15-pin

PWM 21  
PWT 100

## ④ 9-pin

ND 5023  
ND 11xx  
ND 14xx  
ND 21xx  
IK 5xxx  
QC 2000  
QC 3000

### Special cables

#### ③ 15-pin D-sub connector

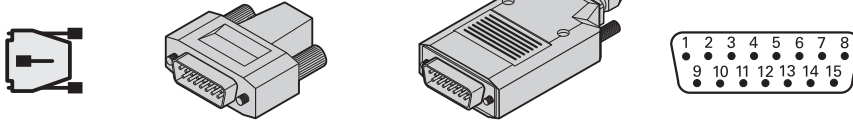

	Power supply				Incremental signals						Other signals			
③	4	12	2	10	1	9	3	11	14	7	13	8 <sup>4)</sup>	6 <sup>4)</sup>	15
	Brown/ Green	Blue	White/ Green	White	Brown	Green	Gray	Pink	Red	Black	Violet	Green/ Black	Yellow/ Black	Yellow
	$U_p$	Sensor 5V	0V	Sensor 0V	$U_{a1}$	$\overline{U}_{a1}$	$U_{a2}$	$\overline{U}_{a2}$	$U_{a0}$	$\overline{U}_{a0}$	$\overline{U}_{aS}$	$L1^{2)}$ $H^{3)}$	$L2^{2)}$ $L^{3)}$	$PWT^{1)}$

**Cable shield** connected to housing;  $U_p$  = Supply voltage

**Sensor:** The sense line is connected in the encoder with the corresponding power line.

Vacant pins or wires must not be used!

1) Conversion from TTL to 11  $\mu A_{PP}$  for the PWT

2) Only with the LIDA 4xx

3) Only with the LIF 481

4) Only ID 354379-xx, ID 354411-xx, ID 355397-xx, ID 355398-xx

**Note:** The listed devices can be connected. For information on additional data, please refer to the Product Information document of the device.

#### ③ 15-pin

PWM 21  
PWT 100

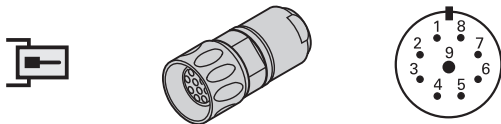
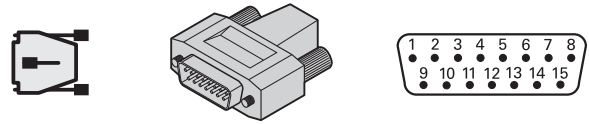
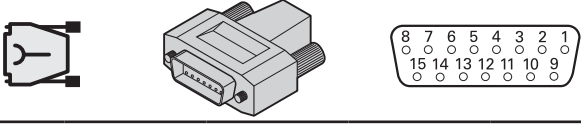
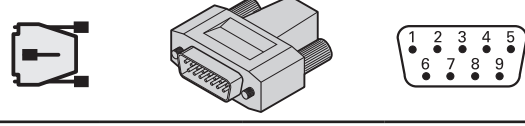
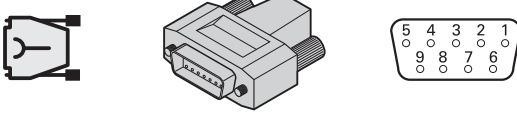

<b>① 9-pin M23 connector</b> 			<b>② 15-pin D-sub connector</b> 						
<b>③ 15-pin D-sub connector</b> 			<b>④ 9-pin D-sub connector</b> 						
<b>⑤ 9-pin D-sub connector</b> 									
	Power supply			Incremental signals					
①	3	4	9	1	2	5	6	7	8
②	4	2	6	1	9	3	11	14	7
③	1	2	13	3	4	6	7	10	12
④	7	1	6	2	3	4	5	8	9
⑤	7	2	4	6	1	8	3	9	5
	$U_P$	0V	Internal shield	$I_1+$	$I_1-$	$I_2+$	$I_2-$	$I_0+$	$I_0-$

**Cable shield** connected to housing;  $U_P$  = Supply voltage  
 Vacant pins or wires must not be used!

**① 9-pin**  
M23



**② 15-pin**  
 ND 280  
 ND 287  
 EIB 74x  
 PWM 21  
 PWT 100  
 ND 7013  
 ND 7013 I/O  
 QC 2000  
 QC 3000

**③ 15-pin**  
IK 220

**④ 9-pin**  
 ND 11xx  
 ND 21xxG

**⑤ 9-pin**  
IK 3xx

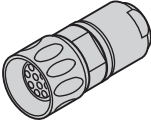



### Special cables

① 9-pin M23 connector									
									
	Power supply			Incremental signals					
①	3	4	9	1	2	5	6	7	8
 1)	Brown	White	Internal shield	Green	Yellow	Blue	Red	Gray	Pink
	<b>U<sub>P</sub></b>	<b>0V</b>	Internal shield	<b>I<sub>1+</sub></b>	<b>I<sub>1-</sub></b>	<b>I<sub>2+</sub></b>	<b>I<sub>2-</sub></b>	<b>I<sub>0+</sub></b>	<b>I<sub>0-</sub></b>

**Cable shield** connected to housing; **U<sub>P</sub>** = Supply voltage  
 Vacant pins or wires must not be used!

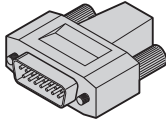
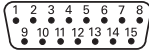
1) Only ID 309780-xx

### Adapter for 1 V<sub>PP</sub> special cables

③ 15-pin D-sub connector					③ 15-pin D-sub connector								
													
	Power supply				Incremental signals						Other signals		
③	1	9	2	11	3	4	6	7	10	12	5/8/ 13/15	14 <sup>1)</sup>	/
	Brown/ Green	Blue	White/ Green	White	Brown	Green	Gray	Pink	Red	Black	/	Violet	Yellow
11 μA <sub>PP</sub>	<b>U<sub>P</sub></b>	<b>Sensor</b> U <sub>P</sub>	<b>0V</b>	<b>Sensor</b> 0V	<b>I<sub>1+</sub></b>	<b>I<sub>1-</sub></b>	<b>I<sub>2+</sub></b>	<b>I<sub>2-</sub></b>	<b>I<sub>0+</sub></b>	<b>I<sub>0-</sub></b>	Reserved, do not assign	Reserved, do not assign	Reserved, do not assign
1 V <sub>PP</sub>					<b>A+</b>	<b>A-</b>	<b>B+</b>	<b>B-</b>	<b>R+</b>	<b>R-</b>			

**Cable shield** connected to housing; **U<sub>P</sub>** = Supply voltage

**Sensor:** The sense line is connected in the encoder with the corresponding power line.  
 Vacant pins or wires must not be used!

1) Only on a 1 V<sub>PP</sub> output







#### ① 9-pin

M23

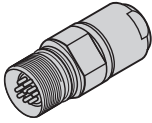
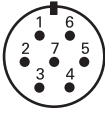
#### ③ 15-pin

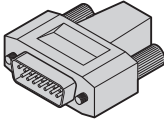
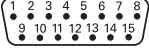
IK 220

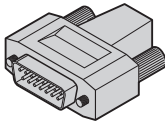
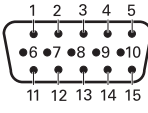
# Touch probes – SE

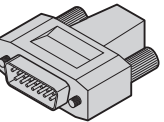
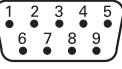
<b>① 7-pin M23 coupling</b>   					<b>② 15-pin, 2-row D-sub connector</b>   											
<b>③ 15-pin, 3-row D-sub connector</b>   					<b>④ 9-pin, 2-row D-sub connector</b>   											
	Power supply					Signals							Serial data			
①	2	/	1	/	7	3	/	5	/	4	6	/	/	/	/	/
②	5, 6 <sup>1)</sup>	/	8	/	1	4	/	3	/	10	7	/	/	/	/	/
③	10	10	9	8	/	6	7	3	11	2	4	/	12	13	14	15
④	4	/	2	/	/	/	/	/	1	9	/	8	/	/	/	/
	U <sub>P</sub>	Sensor U <sub>P</sub>	0V	Sensor 0V	Internal shield	R(TS)	R(TT)	B(TS)	B(TT)	S̄	W̄	S	DATA	DATA	CLOCK	CLOCK

**External shield** lies on connector housing.

**U<sub>P</sub>** = Power supply; **R** = Start signal; **B** = Ready signal; **S**, **S̄** = Trigger signal; **W̄** = Battery warning

**Sensor:** The sense line is connected in the encoder with the corresponding power line.

Vacant pins or wires must not be used!

<sup>1)</sup> Only ID 701919-xx

## ① 7-pin

M23

## ② 15-pin





TNC

## ③ 15-pin

PLB 62xx  
UEC 11x  
UMC 11x

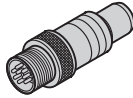
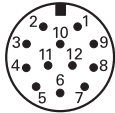
## ④ 9-pin

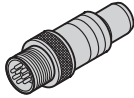
TNC 128  
TNC 320

⑤ 12-pin M12 coupling					⑥ 8-pin M12 coupling								
													
	Power supply				Signals or serial data								
⑤	1	/	12	/	11	5	2	10	3	4	6	7	8
⑥	1	8	5	2	/	/	/	/	3	4	6	7	/
⑤	U <sub>P</sub>	/	0V	/	R(TS)	R(TT)	B(TS)	B(TT)	S	$\bar{S}$	$\bar{W}$	SEL(0)	SEL(1)
⑥	U <sub>P</sub>	Sensor U <sub>P</sub>	0V	Sensor 0V	/	/	/	/	DATA	$\overline{DATA}$	$\overline{CLOCK}$	CLOCK	/

**External shield** lies on connector housing.

**U<sub>P</sub>** = Power supply; **R** = Start signal; **B** = Ready signal; **S**,  $\bar{S}$  = Trigger signal;  $\bar{W}$  = Battery warning

**SEL(0)** = Selection 0 (depends on variant); **SEL(1)** = Selection 1 (depends on variant)

**Sensor:** The sense line is connected in the encoder with the corresponding power line.

Vacant pins or wires must not be used!

## Special cables

⑦ Stripped cable end												
												
	Power supply		Signals									
⑦ <sup>1)</sup>	Brown/ Green	White/ Green	Blue	White	Green	Brown	Gray	Pink	Violet	Yellow	Red	Black
⑦ <sup>2)</sup>	Brown	White	Yellow	/	Gray	/	/	Green	Blue	/	/	/
	U <sub>P</sub>	0V	R(TS)	R(TT)	B(TS)	B(TT)	S	$\bar{S}$	$\bar{W}$	/	SEL(0)	SEL(1)

**External shield** lies on connector housing.

**U<sub>P</sub>** = Power supply; **R** = Start signal; **B** = Ready signal; **S**,  $\bar{S}$  = Trigger signal;  $\bar{W}$  = Battery warning

**SEL(0)** = Selection 0 (depends on variant); **SEL(1)** = Selection 1 (depends on variant)

Vacant pins or wires must not be used!

<sup>1)</sup> Only ID 801285-xx

<sup>2)</sup> Only ID 310193-xx

### ⑤ 12-pin

M12







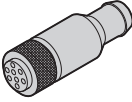
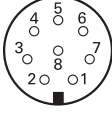

### ⑥ 8-pin

M12

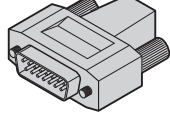
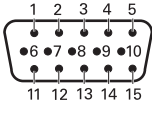
### ⑦ Stripped cable end

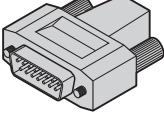
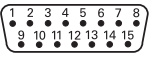
F\*/S/M

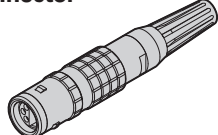
# Touch probes – TS

<b>① 8-pin M12 connector</b>   			<b>② 15-pin, 3-row D-sub connector</b>   					
<b>③ 15-pin, 2-row D-sub connector</b>   			<b>④ 6-pin quick connector</b>   					
	Power supply		Signals					
①	2	7	3	4	1	5	6	8
②	10	9	1	2	3	/	/	/
③	5	8	9	10	3	14 <sup>1)</sup>	11 <sup>1)</sup>	12 <sup>1)</sup>
④	3	1	5	6	3/4	/	/	/
	<b>U<sub>P</sub></b>	<b>0V</b>	<b>S</b>	<b>S̄</b>	<b>B</b>	<b>Trigger NO</b>	<b>Trigger NC</b>	<b>Trigger 0V</b>

**External shield** lies on connector housing.

**U<sub>P</sub>** = Power supply; **B** = Ready signal; **S, S̄** = Trigger signal

Trigger = Floating switching outputs (NC = normally closed, NO = normally open)

Vacant pins or wires must not be used!

<sup>1)</sup> Not with ID 274543-xx

<b>⑤ Stripped cable end</b> 								
	Power supply		Signals					
⑤ <sup>1)</sup>	Blue	Violet	Gray	Pink	White	White/Green	Yellow	Brown/Green
⑤ <sup>2)</sup>	Gray	White/Green	Green	Yellow	Pink	/	/	/
⑤ <sup>3)</sup>	Brown	White	Green	Yellow	Vacant	Vacant	Vacant	Vacant
	<b>U<sub>P</sub></b>	<b>0V</b>	<b>S</b>	<b>S̄</b>	<b>B</b>	<b>Trigger NO</b>	<b>Trigger NC</b>	<b>Trigger 0V</b>

**External shield** lies on connector housing.

**U<sub>P</sub>** = Power supply; **B** = Ready signal; **S, S̄** = Trigger signal

Trigger = Floating switching outputs (NC = normally closed, NO = normally open)

Vacant pins or wires must not be used!

<sup>1)</sup> Only ID 634265-xx

<sup>2)</sup> Only ID 274544-xx

<sup>3)</sup> Only ID 1180354-xx

## ① 8-pin

M12

## ② 15-pin

PLB 62xx  
UEC 11x  
UMC 11x

## ③ 15-pin

TNC  
iTNC

## ④ 6-pin

## ⑤ Stripped cable end

F\*/S/M

# Touch probes – TT

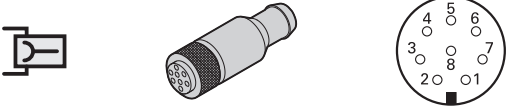
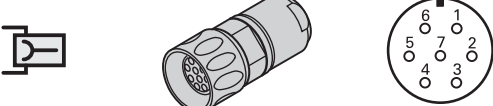
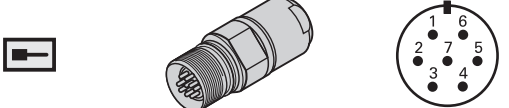
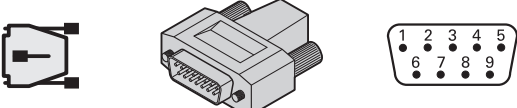
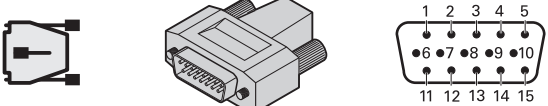
<p>① 8-pin M12 connector</p> 	<p>② 7-pin M23 connector</p> 				
<p>② 7-pin M23 coupling</p> 	<p>③ 9-pin D-sub connector</p> 				
<p>④ 15-pin, 3-row D-sub connector</p> 					
	Power supply		Signals		
①	2	7	3	4	1
②	2+5	1	3	4	6
③	4	2	8	9	1
④	10	9	1	2	11
	U <sub>P</sub>	0V	S	S̄	B

External shield lies on connector housing.

U<sub>P</sub> = Power supply; B = Ready signal; S, S̄ = Trigger signal

Vacant pins or wires must not be used!

① 8-pin

M12

② 7-pin

M23



③ 9-pin

TNC  
(>LE 4xx)

④ 15-pin

PLB 62xx  
UEC 11x  
UMC 11x

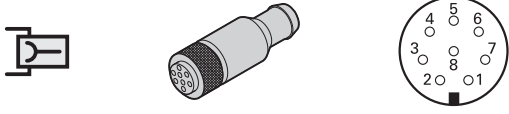
## Special cables

<b>① 8-pin M12 connector</b> 			<b>⑤ Stripped cable end</b> 					
	Power supply		Signals					
①	<b>2</b>	<b>7</b>	<b>3</b>	<b>4</b>	<b>1</b>	<b>5</b>	<b>6</b>	<b>8</b>
⑤ <sup>1)</sup>	Blue	Violet	Gray	Pink	White	White/Green	Yellow	Brown/Green
	<b>U<sub>P</sub></b>	<b>0V</b>	<b>S</b>	<b><math>\bar{S}</math></b>	<b>B</b>	<b>Trigger NO</b>	<b>Trigger NC</b>	<b>Trigger 0V</b>

**External shield** lies on connector housing.

**U<sub>P</sub>** = Power supply; **B** = Ready signal; **S**,  **$\bar{S}$**  = Trigger signal

Trigger = Floating switching outputs (NC = normally closed, NO = normally open)

Vacant pins or wires must not be used!

<sup>1)</sup> Only ID 606317-xx, ID 634265-xx, ID 1083190-xx

## ⑤ Stripped cable end

F\*/S/M

# HEIDENHAIN

## DR. JOHANNES HEIDENHAIN GmbH

Dr.-Johannes-Heidenhain-Straße 5

83301 Traunreut, Germany

☎ +49 8669 31-0

FAX +49 8669 32-5061

E-mail: info@heidenhain.de

www.heidenhain.de

Vollständige und weitere Adressen siehe [www.heidenhain.de](http://www.heidenhain.de)  
For complete and further addresses see [www.heidenhain.de](http://www.heidenhain.de)

<b>DE</b>	<b>HEIDENHAIN Vertrieb Deutschland</b> 83301 Traunreut, Deutschland ☎ 08669 31-3132 FAX 08669 32-3132 E-Mail: hd@heidenhain.de	<b>ES</b>	<b>FARRESA ELECTRONICA S.A.</b> 08028 Barcelona, Spain www.farresa.es	<b>PL</b>	<b>APS</b> 02-384 Warszawa, Poland www.heidenhain.pl
	<b>HEIDENHAIN Technisches Büro Nord</b> 12681 Berlin, Deutschland ☎ 030 54705-240	<b>FI</b>	<b>HEIDENHAIN Scandinavia AB</b> 01740 Vantaa, Finland www.heidenhain.fi	<b>PT</b>	<b>FARRESA ELECTRÓNICA, LDA.</b> 4470 - 177 Maia, Portugal www.farresa.pt
	<b>HEIDENHAIN Technisches Büro Mitte</b> 07751 Jena, Deutschland ☎ 03641 4728-250	<b>FR</b>	<b>HEIDENHAIN FRANCE sarl</b> 92310 Sèvres, France www.heidenhain.fr	<b>RO</b>	<b>HEIDENHAIN Reprezentantă Romania</b> Braşov, 500407, Romania www.heidenhain.ro
	<b>HEIDENHAIN Technisches Büro West</b> 44379 Dortmund, Deutschland ☎ 0231 618083-0	<b>GB</b>	<b>HEIDENHAIN (G.B.) Limited</b> Burgess Hill RH15 9RD, United Kingdom www.heidenhain.co.uk	<b>RS</b>	Serbia → <b>BG</b>
	<b>HEIDENHAIN Technisches Büro Südwest</b> 70771 Leinfelden-Echterdingen, Deutschland ☎ 0711 993395-0	<b>GR</b>	<b>MB Milionis Vassilis</b> 17341 Athens, Greece www.heidenhain.gr	<b>RU</b>	<b>OOO HEIDENHAIN</b> 115172 Moscow, Russia www.heidenhain.ru
	<b>HEIDENHAIN Technisches Büro Südost</b> 83301 Traunreut, Deutschland ☎ 08669 31-1337	<b>HR</b>	Croatia → <b>SL</b>	<b>SE</b>	<b>HEIDENHAIN Scandinavia AB</b> 12739 Skärholmen, Sweden www.heidenhain.se
<b>AR</b>	<b>NAKASE SRL.</b> B1653AOX Villa Ballester, Argentina www.heidenhain.com.ar	<b>HU</b>	<b>HEIDENHAIN Kereskedelmi Képviselet</b> 1239 Budapest, Hungary www.heidenhain.hu	<b>SG</b>	<b>HEIDENHAIN PACIFIC PTE LTD</b> Singapore 408593 www.heidenhain.com.sg
<b>AT</b>	<b>HEIDENHAIN Techn. Büro Österreich</b> 83301 Traunreut, Germany www.heidenhain.de	<b>ID</b>	<b>PT Servitama Era Toolsindo</b> Jakarta 13930, Indonesia E-mail: ptset@group.gts.co.id	<b>SK</b>	<b>KOPRETINA TN s.r.o.</b> 91101 Trenčín, Slovakia www.kopretina.sk
<b>AU</b>	<b>FCR MOTION TECHNOLOGY PTY LTD</b> Laverton North Victoria 3026, Australia E-mail: sales@fcrmotion.com	<b>IL</b>	<b>NEUMO VARGUS MARKETING LTD.</b> Holon, 58859, Israel E-mail: neumo@neumo-vargus.co.il	<b>SL</b>	<b>NAVO d.o.o.</b> 2000 Maribor, Slovenia www.heidenhain.si
<b>BE</b>	<b>HEIDENHAIN N.V.</b> 1760 Roosdaal, Belgium www.heidenhain.be	<b>IN</b>	<b>HEIDENHAIN Optics &amp; Electronics India Private Limited</b> Chetpet, Chennai 600 031, India www.heidenhain.in	<b>TH</b>	<b>HEIDENHAIN (THAILAND) LTD</b> Bangkok 10250, Thailand www.heidenhain.co.th
<b>BG</b>	<b>ESD Bulgaria Ltd.</b> Sofia 1172, Bulgaria www.esd.bg	<b>IT</b>	<b>HEIDENHAIN ITALIANA S.r.l.</b> 20128 Milano, Italy www.heidenhain.it	<b>TR</b>	<b>T&amp;M Mühendislik San. ve Tic. LTD. ŞTİ.</b> 34775 Y. Dudullu – Ümraniye-Istanbul, Turkey www.heidenhain.com.tr
<b>BR</b>	<b>HEIDENHAIN Brasil Ltda.</b> 04763-070 – São Paulo – SP, Brazil www.heidenhain.com.br	<b>JP</b>	<b>HEIDENHAIN K.K.</b> Tokyo 102-0083, Japan www.heidenhain.co.jp	<b>TW</b>	<b>HEIDENHAIN Co., Ltd.</b> Taichung 40768, Taiwan R.O.C. www.heidenhain.com.tw
<b>BY</b>	<b>GERTNER Service GmbH</b> 220026 Minsk, Belarus www.heidenhain.by	<b>KR</b>	<b>HEIDENHAIN Korea LTD..</b> Gasam-Dong, Seoul, Korea, 153-782 www.heidenhain.co.kr	<b>UA</b>	<b>Gertner Service GmbH Büro Kiev</b> 02094 Kiev, Ukraine www.heidenhain.ua
<b>CA</b>	<b>HEIDENHAIN CORPORATION</b> Mississauga, Ontario L5T2N2, Canada www.heidenhain.com	<b>MX</b>	<b>HEIDENHAIN CORPORATION MEXICO</b> 20290 Aguascalientes, AGS., Mexico E-mail: info@heidenhain.com	<b>US</b>	<b>HEIDENHAIN CORPORATION</b> Schaumburg, IL 60173-5337, USA www.heidenhain.com
<b>CH</b>	<b>HEIDENHAIN (SCHWEIZ) AG</b> 8603 Schwerzenbach, Switzerland www.heidenhain.ch	<b>MY</b>	<b>ISOSERVE SDN. BHD.</b> 43200 Balakong, Selangor E-mail: sales@isoserve.com.my	<b>VN</b>	<b>AMS Co. Ltd</b> HCM City, Vietnam E-mail: davidgoh@amsvn.com
<b>CN</b>	<b>DR. JOHANNES HEIDENHAIN (CHINA) Co., Ltd.</b> Beijing 101312, China www.heidenhain.com.cn	<b>NL</b>	<b>HEIDENHAIN NEDERLAND B.V.</b> 6716 BM Ede, Netherlands www.heidenhain.nl	<b>ZA</b>	<b>MAFEMA SALES SERVICES C.C.</b> Midrand 1685, South Africa www.heidenhain.co.za
<b>CZ</b>	<b>HEIDENHAIN s.r.o.</b> 102 00 Praha 10, Czech Republic www.heidenhain.cz	<b>NO</b>	<b>HEIDENHAIN Scandinavia AB</b> 7300 Orkanger, Norway www.heidenhain.no		
<b>DK</b>	<b>TPTEKNIK A/S</b> 2670 Greve, Denmark www.tp-gruppen.dk	<b>NZ</b>	<b>Llama ENGINEERING Ltd</b> 5012 Wellington, New Zealand E-mail: info@llamaengineering.co.nz		
		<b>PH</b>	<b>MACHINEBANKS' CORPORATION</b> Quezon City, Philippines 1113 E-mail: info@machinebanks.com		

